

Revision of the Iberian Siphonuridae (Ephemeroptera)

by

Denise STUDEMANN, Ivan TOMKA and Peter LANDOLT

D. STUDEMANN, I. TOMKA, and P. LANDOLT: Revision of the Iberian Siphonuridae (Ephemeroptera).

Aquatic Insects, Vol. 14 (1992), No. 4, pp. 195-211.

The description of the six known species of Iberian Siphonuridae has now been completed for all stages. A new Iberian *Siphonurus*-species, *S. montanus* Studemann, sp. n., is described at the imaginal, subimaginal and larval stages. A differential diagnosis is given for *S. flavidus*, *S. hispanicus*, *S. lusoensis* and *S. montanus* Studemann, sp. n. A key to the male imagines of all Iberian Siphonuridae is included.

D. STUDEMANN, I. TOMKA and P. LANDOLT, Department of Entomology, Institute of Zoology, University of Fribourg, Pérolles, CH-1700 Fribourg, Switzerland.

INTRODUCTION

The Siphonuridae are well represented in the Iberian Peninsula. In his faunistic compilation, Alba-Tercedor (1981) lists *Siphonurus flavidus* (Pictet, 1865), *S. hispanicus* Demoulin, 1958, *S. lacustris* (Eaton, 1870) and *S. lusoensis* Puthz, 1977. To this list, one can add *S. aestivalis* (Eaton, 1903) found by Pardo (1990) and *S. ireneae* Alba-Tercedor 1990.

S. lacustris and *S. aestivalis* are well-described species (Malzacher, 1981, Studemann *et al.*, 1988). *S. ireneae* is described from all stages by Alba-Tercedor (1990). The first descriptions of *S. flavidus* by Pictet (1865) and Eaton (1871, 1885) were completed by Puthz (1977) and Alba-Tercedor (1984), but only for the winged stages. Demoulin (1958) described the larvae, subimagines and female imago of *S. hispanicus*. *S. lusoensis* was known at the imaginal stage only (Puthz, 1977).

Our explorations in Spain and Portugal (Fig. 1, localities with a number) in April 1990 enabled us to collect many Siphonuridae and to complete the descriptions of *S. flavidus*, *S. hispanicus* and *S. lusoensis* as well as to describe a new species: *S. montanus* Studemann, sp.n.

METHODS

Most of the specimens were collected as larvae by kicksampling using a nylon net with 100 µm mesh size. Larvae were preserved in 80% ethanol. Mouthparts and abdominal gills were dissected and

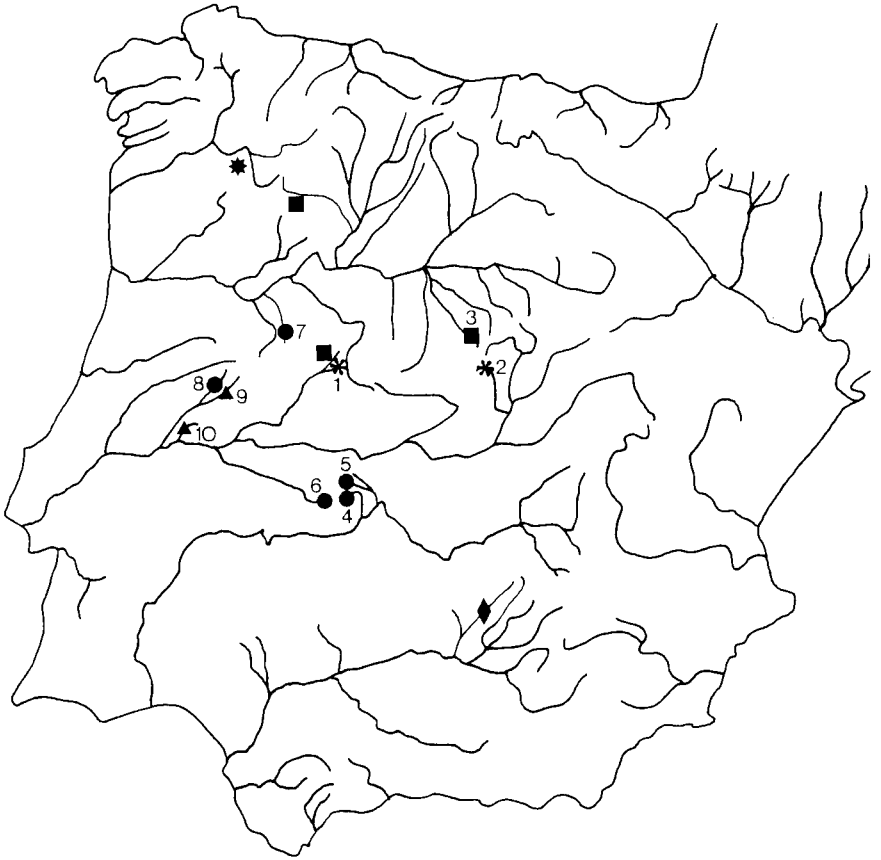

Fig. 1. New localities where *Siphonurus*-species were collected.

**S. aestivalis*, ■ *S. flavidus*, ● *S. hispanicus*, ◆ *S. ireneae*, ▲ *S. lusoensis*, **S. montanus*.

mounted in Heinze-medium (Heinze, 1952) on slides, as well as nymphal skins. Illustrations were made with the aid of a drawing tube attached to a Wild M3C stereomicroscope or to a Leitz Laborlux S microscope.

Most of the imagines were obtained by rearing larvae. The others were collected by using a handnet as they swarmed above the stream, and some emerging subimagines during their flight to the vegetation. The winged stages were preserved in the same manner as the larvae. The described coloration pattern of the specimens is that of the living animals. The natural coloration is preserved on coloured photographs and on frozen specimens. All the material, including the types, is deposited in our Institute in Fribourg.

DESCRIPTIONS

Siphonurus montanus Studemann, sp. n. (Figs. 2-13)

Male imago. Dimensions (in mm): body length (without forceps) 14-16, forewing length 13.5-15.5, forewing width 5.2-6.0, hindwing length 6.5-7.5, hindwing

width 4.0-4.5. General coloration brown with white sternites and yellowish wings. Head: white with following brown parts: frons, base of ocelli and eyes, narrow transversal band on clypeus, flagellum of antennae; upper portion of eyes grey, lower portion brown. Thorax: prothorax brown with white posterior margin; meso- and metathorax brown with white spots, dorsally brown. Wings (Figs. 4-5): membrane of anterior wing hyaline with orange base in C and Sc areas; in many specimens the membrane is tinged with yellow. Veins brown except the yellow C and Sc; transversal veins shaded with brown in the three anterior areas; posterior wing with hyaline membrane and orange spot at base; C yellow, other veins brown, paler in the posterior part; nervation as in *S. aestivalis*. Legs: foreleg brown, mid- and hindleg yellow. Gradation of tarsal segments in foreleg $1=2=3=4>5$, in mid- and hindleg $1=5=2>3>4$. Abdomen (Figs. 2-3): tergites light brown with dark brown triangular spot laterally on each segment; sternites 2-8 white with two little brown round spots on each segment; sternite 1 light brown, sternite 9 with dark brown maculation on its anterior and lateral sides. In some specimens, the sternites 2-4 present a weak maculation in form of horseshoe.

Genitalia (Figs. 6-7): genital plate white in the middle, brown laterally, forceps brown; forceps base with short and curved inner protuberance; penis white with dark brown sclerites; lateral sclerite rounded at apex; ventral sclerite without median protrusion and without spines; gonoporus bordered with two narrow strongly sclerotised bows: the ventral bow is narrow up to the end, the dorsal bow is enlarged apically and directed to the external part of the penis lobe; they join laterally in a pad; transversal dorsal sclerite with triangular shape. Cerci: light brown.

Female imago. Dimensions (in mm): body length 15-19, forewing length 14.0-16.5, forewing width 5.3-6.0, hindwing length 6.5-7.5, hindwing width 3.7-4.5. Coloration of body and wings similar to the male imago, except the yellow foreleg and the brown eyes; the brown coloration on the tergites is lighter in the female; the sternite 9 is white. The live female imagines present a green coloration of the abdominal segments 2-6, due to the presence of the eggs. Legs: gradation of tarsal segments in foreleg $1>2=5=3>4$, in mid- and hindleg similar to the male imago. Genitalia: the subgenital plate is drawn on Fig. 8.

Male subimago. General coloration as in the male imago, except the darker tarsi and cerci; wings opaque grey with red-orange maculation at the base and yellowish C and Sc areas.

Female subimago. General coloration as in the female imago, except the brown legs and cerci; wings as in the male subimago.

Larvae. Dimensions of mature larvae (in mm): body length 16-18, caudal filaments 8-9. General aspect: coloration brown dorsally and white ventrally. Gills, legs and mouthparts present the same configuration as in *S. aestivalis*. Head: yellow with following brown parts: clypeus, labrum, base and incisivi of mandibles, distal part of maxillae, two longitudinal spots on the vertex, two triangular spots on the frons; composed eyes dark grey, ocelli grey with black base. Thorax: brown with many russet-red spots. On old larvae red spot of wing base visible

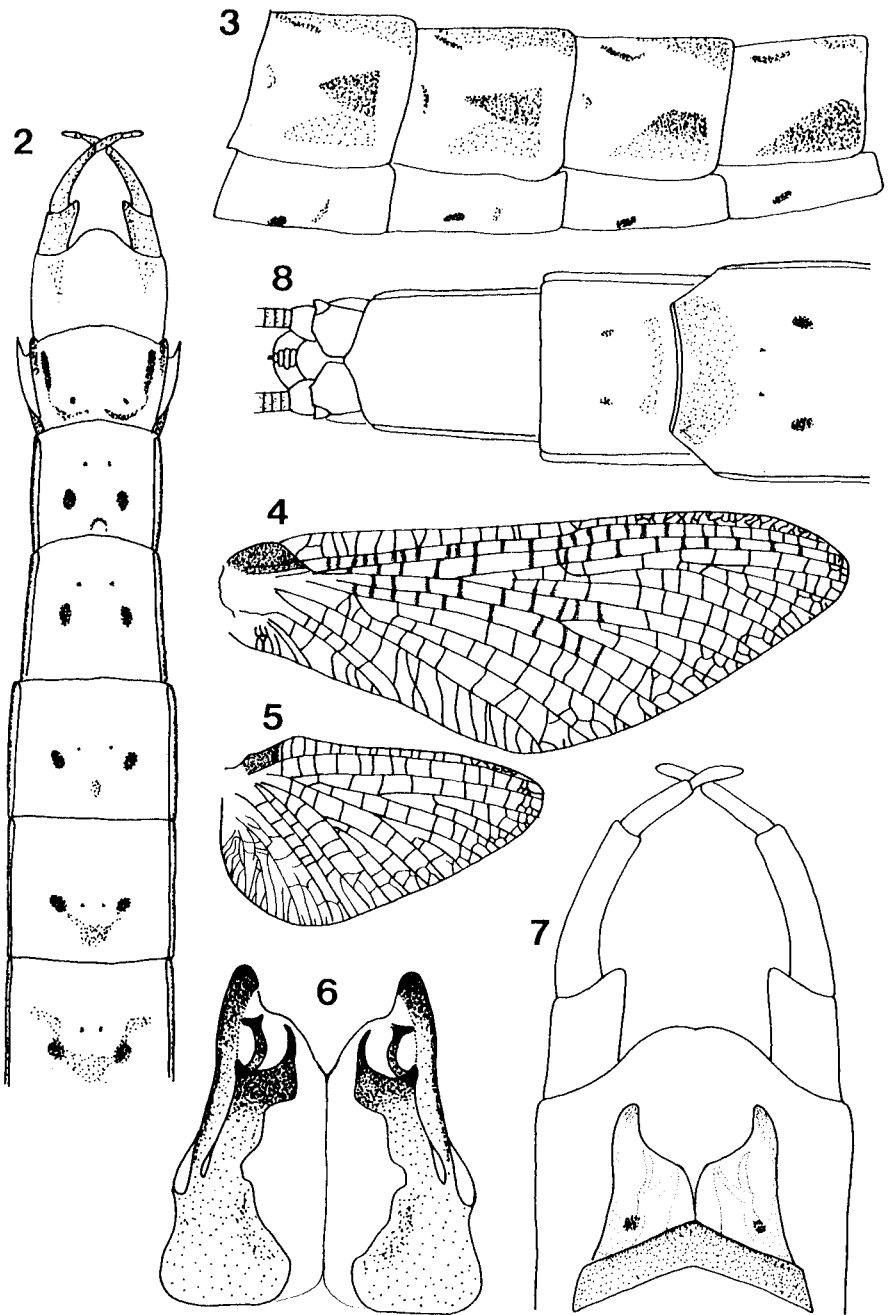

Figs. 2-8. *S. montanus*. Figs. 2-7, ♂ imago: 2, abdominal sternites 4-9; 3, abdominal segments 5-8, lateral view; 4, forewing; 5, hindwing; 6, penis, ventral view; 7, genitalia, dorsal view. Fig. 8, ♀ imago, abdominal sternites 7-9.

through wing pad. Legs: yellow, articulations and tooth weakly darker, femur with a longitudinal spot on the distal part. Abdomen: tergites (Fig. 9) brown with a darker maculation in form of two diagonal short lines; sternites (Fig. 10) white with a dark band laterally and two little round spots in the middle of each segment; postero-lateral projections dark brown apically. The spines on tergites and sternites are similar to those of *S. aestivalis* (Figs. 12-13). Genitalia: the developing penis does not possess any spines (Fig. 11). Caudal filaments: proximal part brown, distal third yellow, paracercus lighter; setae in the median part of the filament dark.

Differential diagnosis. Size and general aspect of larvae and imagines make *S. montanus* and *S. lusoensis* two closely related species. The penis shape clearly shows the distinction: in *S. montanus*, the sclerites bordering the gonoporus are dissimilar, the ventral one being pointed at the apex, the dorsal one ending in an enlargement and directed to the external part of the penis lobe (Fig. 6). The abdominal maculation of *S. montanus*, a few little brown spots on white background (Figs. 2, 8, 10), is typical for adults and old larvae.

Type material (Fig. 1, locality 1). Holotype: male imago, SPAIN, Rio Sangusin near La Calzedada de Bejar, Sierra de Gredos, prov. Salamanca, alt. 750 m, 15.5.90. Allotype: female imago, same data

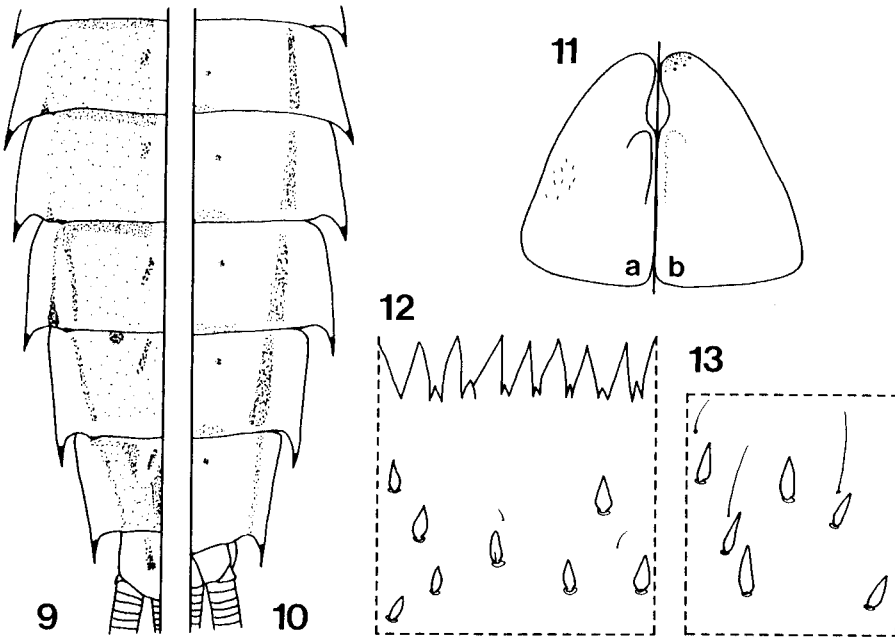

Figs. 9-13. *S. montanus*, larvae: 9, abdominal tergites; 10, abdominal sternites; 11, developing penis, a, dorsal view, b, ventral view; 12, hind margin of the 4th tergite; 13, hairs on the surface of the 4th sternite.

as holotype. Paratypes: 11 larvae, 30 nymphal skins, 6 subimagines, 2 male imagines, 1 female imago, same locality as holotype, 14.4-24.5.90.

Other material examined (Fig. 1, locality 2). SPAIN, Rio Samburriel in Manzanares el Real, Sierra de Guadarrama, prov. Madrid, alt. 900 m, 9.4-1.6.90: 14 larvae, 4 nymphal skins, 7 subimagines, 3 male imagines, 3 female imagines.

Etymology: *montanus*, adj., both localities are situated in the mountains.

Biology and ecology. The larvae were collected at altitudes of 750 m to 900 m and in relatively cold water (11-14°C). Rio Sangusin and Rio Samburriel are medium-size rivers which shelter *S. montanus* in their quiet places. The larvae were captured in mid-April and reared to imagines. The moults to subimagines and imagines occurred during May.

***Siphonurus flavidus* (Pictet, 1865) (Figs. 14-18, 43-44)**

Larvae. Dimensions of mature larvae (in mm): body length 16-17, caudal filaments 6-7. General aspect: coloration brown dorsally and yellow ventrally. Gills, legs and mouthparts present the same configuration as in *S. aestivalis*. Head: light brown with a yellow longitudinal band in the middle of the frons; antennae yellow; labium and maxillae white; ocelli grey with black base; composed eyes dark grey. Thorax: grey-brown with some darker spots. Legs: yellow with dark articulations, distal part of tarsus brown; femur with a longitudinal grey spot on its distal part. Abdomen: tergites yellow with brown maculation as in Fig. 14; sternites (Fig. 15) yellow with brown longitudinal band laterally and orange spots paramedially; postero-lateral projections long and thin, reaching the distal margin of the paraprot, brown apically. The spines on the hind margin of the tergites are disposed at wide intervals, rarely separated by little spines (Fig. 17). The surface of the tergites is provided with many splintery hairs (Fig. 17). The surface of the sternites is covered with long and thin hairs (for each hair: width / length < 0.18) (Fig. 18). These hairs are longer than the spines on the hind margin of the tergites. Genitalia: the developing penis is pointed at the apex and does not possess any spines (Fig. 16). Caudal filaments: yellow, brown setae in the median part of the filaments.

Subimagines and imagines: described by Pictet (1865), Eaton (1871, 1885), Puthz (1977) and Alba Tercedor (1984). The penis is drawn on Figs. 43-44.

Differential diagnosis. The larvae of *S. flavidus* can be separated from those of the other *Siphonurus*-species by the spines on the sternites, which are longer than those on the hind margin of the tergites (Figs. 17-18). In all the other species of *Siphonurus*, the spines on the sternites are shorter than those on the hind margin of the tergites. In the male larvae of *S. flavidus*, the developing penis is pointed at the apex whereas it is rounded in the other species. The male imago of *S. flavidus* presents a typical penis shape with pointed lateral sclerites and a long ventral sclerite (Fig. 43).

Material examined (Fig. 1, locality 3). SPAIN, Arroyo de Roduelos, near San Ildefonso, prov. Segovia, alt. 1150 m, 15.4-1.6.90: 2 larvae, 10 nymphal skins, 3 subimagines, 2 male imagines, 5 female imagines.

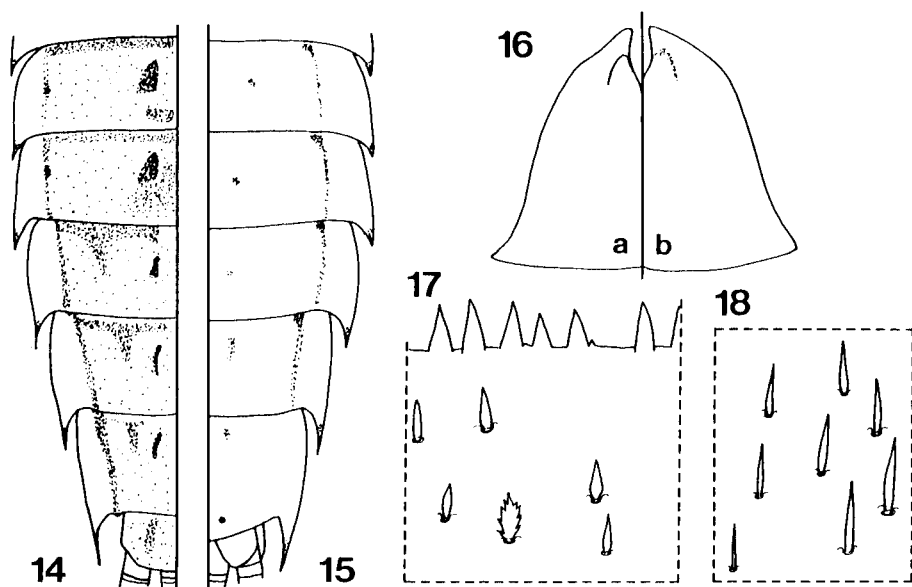

Figs. 14-18. *S. flavidus*, larvae: 14, abdominal tergites; 15, abdominal sternites; 16, developing penis, a, dorsal view, b, ventral view; 17, hind margin of the 4th tergite; 18, hairs on the surface of the 4th sternite.

Biology and ecology. The larvae were collected in mid-April in the village of the type locality. The rivulet of Roduelos, not more than 1 m in width and 30 cm in depth, meanders slowly through meadows. The bottom was sandy and the water surface covered with *Ranunculus* sp. The larvae were reared, and the emergence occurred at the end of May. The subimagines moulted to imagines after 2-3 days.

***Siphonurus hispanicus* Demoulin 1958 (Figs. 19-28)**

Male imago. Dimensions (in mm): body length (without forceps) 16, forewing length 14.5-15.5, forewing width 5.4-6.0, hindwings length 6.8-7.0, hindwings width 4.2-4.5. General coloration yellow and russet-red; wings translucent with dark nervation and a red spot at the base. Head: transversal band on clypeus, pedicellus and flagellum of antennae; upper portion of eyes red-brown, lower portion blackish; ocelli grey. Thorax: prothorax brown with a narrow white band on the distal margin; meso- and metathorax yellow with many russet-red spots laterally and four longitudinal brown bands dorsally. Wings: membrane hyaline except yellowish pterostigma and wine-red base of C and Sc areas in both wings; veins dark brown, paler in posterior part of hindwing; nervation as in the female imago described by Demoulin (1958). Legs: foreleg light brown with articula-

tions and tarsus 5 darker; mid- and hindleg yellow, distally darker. Gradation of tarsal segments in foreleg $1=2=3=4>5$; in mid- and hindleg $1=5=2>3>4$. Abdomen (Figs. 19-20): tergites brown with darker maculation consisting on each segment of two longitudinal short lines paramedially and a triangular spot postero-laterally; tergite 9 with darker maculation laterally; sternites yellow with an orange maculation in form of a horseshoe opened distally; sternite 9 dark brown laterally.

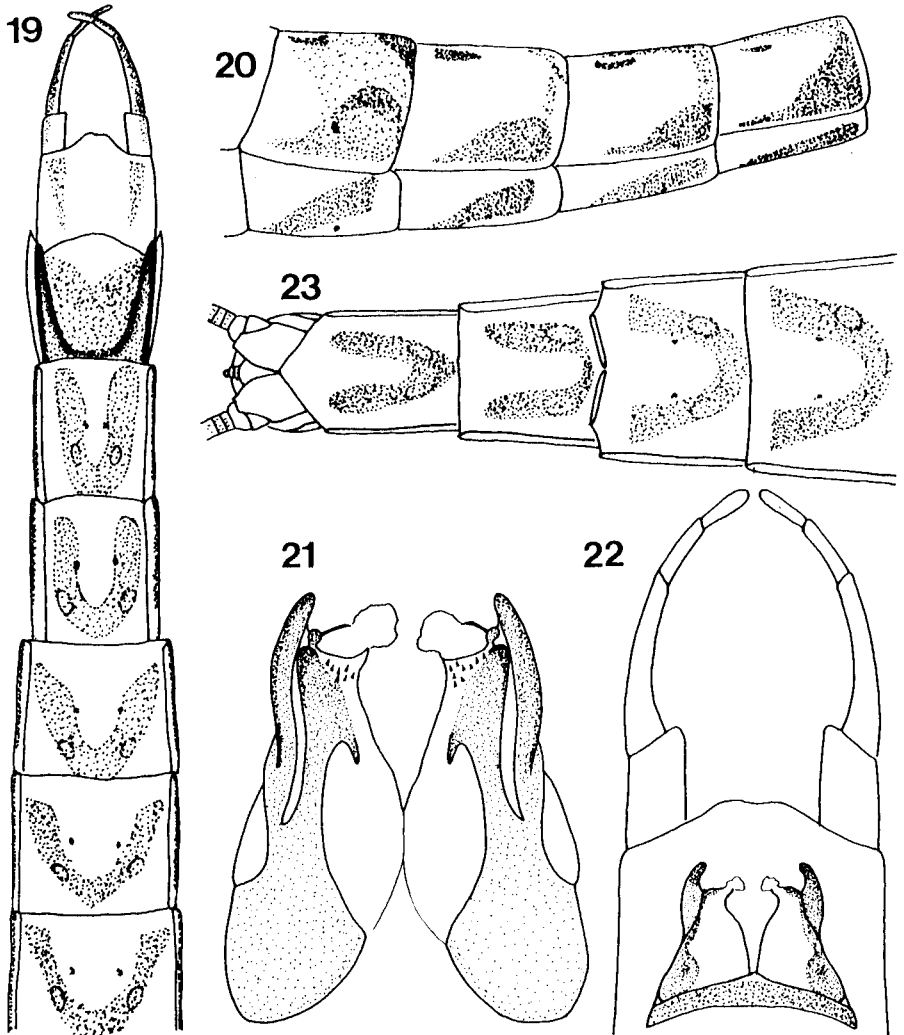

Figs. 19-23. *S. hispanicus*. Figs. 19-22, ♂ imago: 19, abdominal sternites 4-9; 20, abdominal segments 5-8, lateral view; 21, penis, ventral view; 22, genitalia, dorsal view. Fig. 23, ♀ imago, abdominal sternites 6-9.

Genitalia (Figs. 21-22): genital plate and forceps light brown, segments 2 and 3 of forceps often darker; forceps base with short and rounded inner protuberance; penis white with brown sclerites; lateral sclerite slightly rounded at the apex; ventral sclerite with a narrow median protrusion and provided with strong spines medio-apically; ejaculation opening provided laterally with a spherical pad directed ventrally. Cerci: brown.

Female imago, male and female subimagines, larvae: described by Demoulin (1958). The abdominal coloration pattern of the female imago is drawn on Fig. 23. The larva is shown on Figs. 24-28.

Differential diagnosis. Because of the spines on the ventral sclerites of the penis, *S. hispanicus* is closely related to *S. aestivalis* and *S. croaticus*. In contrast to these last species, *S. hispanicus* presents a typical pad on the external part of the ejaculation opening (Fig. 21), already visible in the subimago. The big size of the imagines and the red spot at the base of the wings are common for *S. hispanicus*, *S. lusoensis* and *S. montanus*, but the russet maculation on the sternites in form of horseshoes is typical for *S. hispanicus* (Figs. 19, 23). The male larvae of *S. hispanicus* can be distinguished from those of the other *Siphonurus*-species by the presence of many spines arranged in a bow on the ventral side of the developing

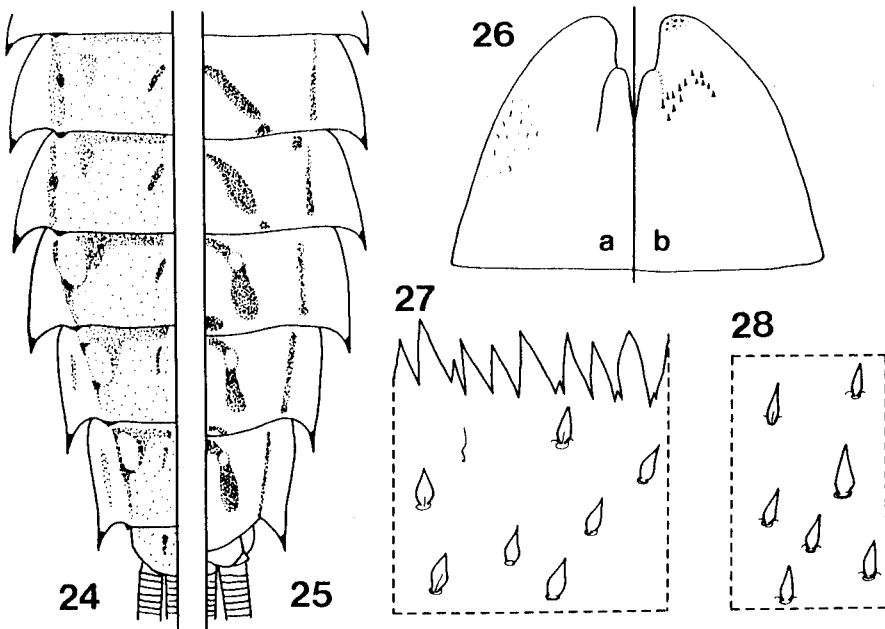

Figs. 24-28. *S. hispanicus*, larvae: 24, abdominal tergites; 25, abdominal sternites; 26, developing penis, a, dorsal view, b, ventral view; 27, hind margin of the 4th tergite; 28, hairs on the surface of the 4th sternite.

penis (Fig. 26). On old larvae, the russet pattern in form of horseshoes on the sternites characterises *S. hispanicus* (Fig. 25).

Material examined (Fig. 1, localities 4-8). SPAIN, Rio Guadalupejo near Guadalupe, prov. Cáceres, alt. 525 m (Fig. 1, locality 4, holotype locality), 10-16.4.90: 70 larvae, 3 nymphal skins, 13 female subimagines, 18 female imagines. SPAIN, Rio Galiguela near La Calera, prov. Cáceres, alt. 680 m (Fig. 1, locality 5), 10.4-22.5.90: 32 larvae, 3 nymphal skins, 1 female subimago, 2 male imagines, 1 female imago. Rio Magasca near Trujillo, prov. Cáceres, alt. 450 m (Fig. 1, locality 6), 11.4.90: 11 larvae, 1 male subimago. SPAIN, Rio Tenebrilla in Tenebron near Ciudad Rodrigo, prov. Salamanca, alt. 650 m (Fig. 1, locality 7), 14.4-1.6.90: 44 larvae, 20 nymphal skins, 5 subimagines, 9 male imagines, 18 female imagines. PORTUGAL, Ribeira Ocrexa near Castelo Branco, prov. Beira Baixa, alt. 150 m (Fig. 1, locality 8), 12.4-16.5.90: 12 larvae, 6 nymphal skins, 3 subimagines, 2 male imagines, 5 female imagines.

Biology and ecology. The larvae were collected in April in small and medium-size rivers. They were concentrated in quiet places provided with vegetation. In Guadalupe, the hatching to subimagines occurred on *Carex* sp. at 3-4 p.m., and the subimagines flew directly to the vegetation bordering the river up to 4 m high. The subimagines moulted to imagines after 3-6 days. The larvae from the other localities were reared and they moulted during May. The population in the Guadalupejo river was composed nearly exclusively of female individuals: among 100 specimens we found only three young male larvae and one male nymphal skin. Most of the female subimagines and imagines were parasitized with nematods belonging to the family Mermithidae. The abdomen was filled with one or two worms, which took the place of the eggs.

Siphonurus lusoensis Puthz 1977 (Figs. 29-40)

Male imago. Dimensions (in mm): body length (without forceps) 16-17, forewing length 14.0-14.5, forewing width 5.5-6.0, hindwing length 7.0-8.0, hindwing width 4.5-5.0. General coloration brown and yellow, wings brown and yellow with a red spot at the base. Head: white with following dark brown parts: frons, base of ocelli and eyes, broad transversal band on clypeus, pedicellus and flagellum of antennae; upper portion of eyes dark grey, lower portion dark brown; ocelli grey. Wings (Figs. 31-32): membrane of anterior wing hyaline with a red spot at the base of the C and Sc areas, anterior part of wing often tinged with yellow; nervation brown, transversal veins strongly shaded with brown, especially in the anterior proximal part; nervation as in *S. aestivalis*. Legs: foreleg brown, mid- and hindleg yellow, darker apically and at the articulations. Gradation of tarsal segment in foreleg 1=2=3=4>5, in mid- and hindleg 1=5=2>3>4. Abdomen (Figs. 29-30): tergites brown with a dark spot on the lateral parts of each segment; spots darker on tergite 9; sternites yellow with brown maculation on each segment as follows: from sternite 2 to 8: two round brown spots, three oval russet spots; drawing stronger on the proximal sternites where they can join together; sternite 1 brown in its proximal part, sternite 9 dark brown laterally and proximally.

Genitalia (Figs. 33-34): genital plate yellow in the middle, brown laterally; forceps brown; forceps base with long and pointed protuberance on its inner side; penis white with brown sclerites, lateral sclerite rounded at the apex; ventral

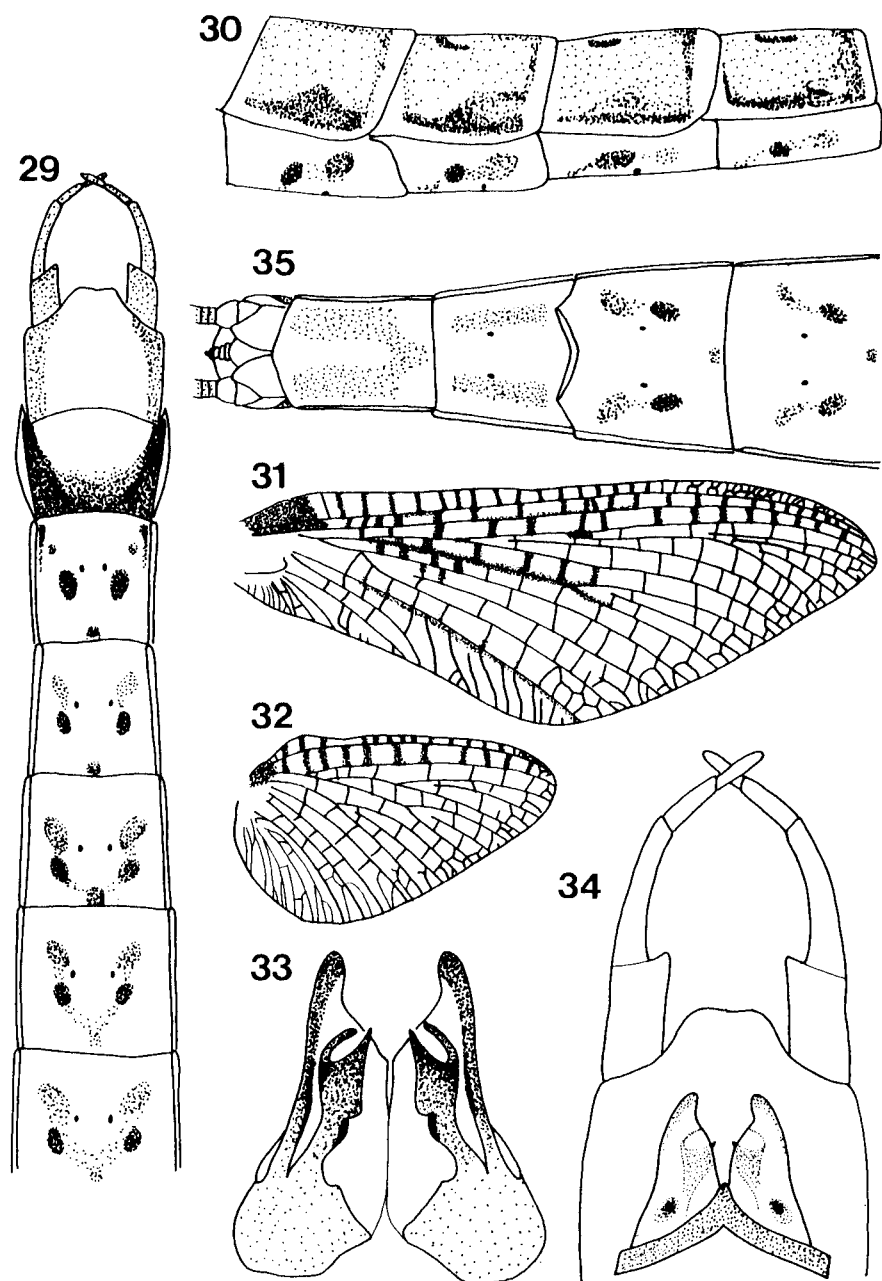

Figs. 29-35. *S. lusoensis*. Figs. 29-34, ♂ imago: 29, abdominal sternites 4-9; 30, abdominal segments 5-8, lateral view; 31, forewing; 32, hindwing; 33, penis, ventral view; 34, genitalia, dorsal view. Fig. 35, ♀ imago, abdominal sternites 6-9.

sclerite without median protrusion and without spines; ejaculation opening bordered with two narrow bows directed to the internal side of the penis lobe and without lateral pad; transversal dorsal sclerite pointed in the middle on its posterior margin, the anterior margin can be right or pointed incurved. Cerci: brown.

Female imago. Dimensions (in mm): body length 17-18, forewing length 15-17, forewing width 5.5-6.6, hindwing length 7.0-8.0, hindwing width 4.0-4.5. Coloration similar to the male imago except as follows: forelegs yellow, eyes russet-brown; the brown coloration on the tergites is lighter on the female, abdomen blue-green from segment 1 to 6 because of the presence of eggs; maculation on sternite 8 in form of two brown longitudinal bands; on sternite 9 a brown drawing in form of a horseshoe opened distally (Fig. 35). Legs: gradation of tarsal segments in foreleg $1 > 2 = 5 = 3 > 4$, in mid- and hindleg similar to the male imago. Genitalia: the subgenital plate is drawn on Fig. 35.

Male subimago. General coloration as in the male imago except the darker legs and cerci; wings opaque grey with a red spot at the base and yellowish C and Sc areas.

Female subimago. General coloration as in the female imago, except the darker legs and cerci; wings as in the male subimago.

Larvae. Dimensions of mature larvae (in mm): body length 17-19, caudal filaments 8-9. General aspect: coloration brown dorsally and yellow ventrally. Gills, legs and mouthparts present the same configuration as in *S. aestivalis*. Head: yellow with following brown parts: clypeus, labrum, base and incisivi of mandibles, distal part of maxillae, two longitudinal spots on the vertex, two triangular spots on the frons; composed eyes dark grey, ocelli grey with black base. Thorax: brown with many russet-red spots. In old larvae red spot of wing base visible through wing pad. Legs: yellow, articulations and tooth weakly darker, femur with a longitudinal spot on its distal part. Abdomen: tergites (Fig. 36) brown with darker maculation; sternites (Fig. 37) yellow with brown maculation on each segment as follows: a dark band laterally, two round spots in the middle, variably followed by posterior oval spots; postero-lateral projections dark brown apically. The spines on tergites and sternites are similar to those of *S. aestivalis* (Figs. 39-40).

Genitalia: the developing penis does not possess any spines (Fig. 38). Caudal filaments: russet-brown proximally with yellow distal third, paracercus lighter; setae in the median part of the filaments dark.

Differential diagnosis. *S. lusoensis* is closely related to *S. montanus*. The male imago of *S. lusoensis* can be distinguished by the typical penis shape. The sclerites bordering the gonoporus form an open circle, they both remain narrow apically and they are both directed to the internal side of the penis lobe (Fig. 33). The abdominal maculation of *S. lusoensis*, made on each yellow sternite of five spots which can be united (Figs. 29, 35, 37), is typical for adults and larvae.

Material examined (Fig. 1, localities 9-10). PORTUGAL, Ribeira Liria near Taberna Seca, Castelo Branco, prov. Beira Baixa, alt. 150 m (Fig. 1, locality 9) 12.4-11.5.90: 14 larvae, 18 nymphal; skins, 4 subimagines, 6 male imagines, 15 female imagines. PORTUGAL, affluent of the Tejo near Sarnadas, Castelo Branco, prov. Beira Baixa, alt. 200 m (Fig. 1, locality 10), 12.4.90: 26 larvae, 20 male imagines, 3 female imagines.

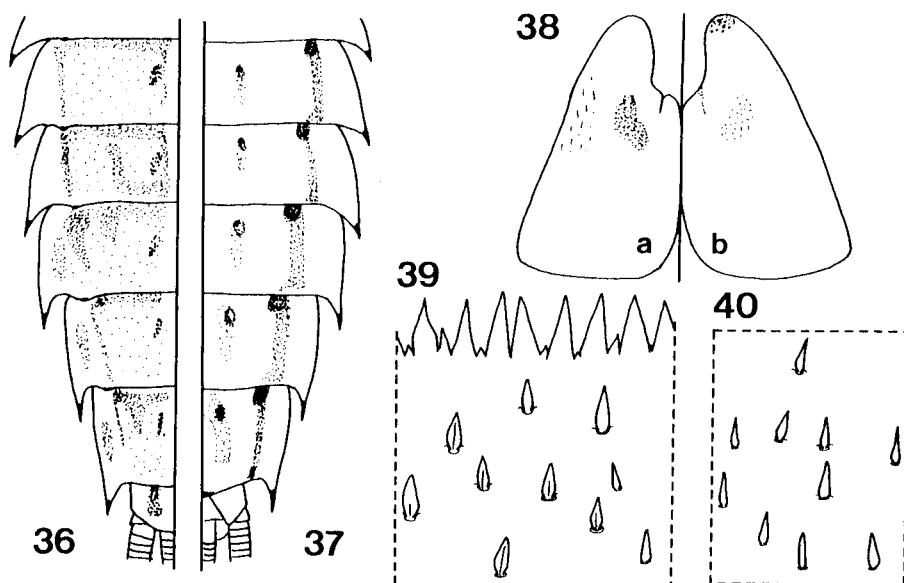

Figs. 36-40. *S. lusoensis*, larvae: 36, abdominal tergites; 37, abdominal sternites; 38, developing penis, a, dorsal view, b, ventral view; 39, hind margin of the 4th tergite; 40, hairs on the surface of the 4th sternite.

Biology and ecology. The larvae were collected in mid-April at low altitude (150 m to 200 m) in Portugal, in streams with relatively warm water (17-19°C). The affluent of the Tejo is a very small rivulet flowing slowly through meadows and nearly covered over with vegetation. The imagines were captured in flight in late afternoon till 7 p.m. They flew in great number, up to 10 m above the water surface. The Liria river is a medium-size meandering river. The larvae of *S. lusoensis* were collected in quiet places. The larvae were reared and the emergence occurred from mid-April to mid-May. The subimagines moulted to imagines after 4-7 days.

Discussion. *S. lusoensis* was known only from one male imago and one female imago, collected in May 1906, determined as "*Baetis flavida*" by Navas and described by Puthz (1977). These specimens are no longer found in the Museum of Coimbra (personal communication of the Curator) where they were deposited by Dr. Puthz (personal communication of Dr. Puthz). We prospected the type locality (Ribeira Ocrexa in Portugal) in April 1990 and found there only *S. hispanicus*. However, in two neighbouring rivers, Ribeira Liria (2 km far from R. Ocrexa) and an affluent of the Tejo (10 km from R. Ocrexa), we collected specimens with the same penis shape as drawn by Puthz (1977). The wings of our individuals do not present the little spots drawn by Puthz (1977), but the transversal veins are strongly shaded with brown. Our specimens are bigger and the gradation of the

tarsal segments is not exactly the same, but the examination of a great number of *Siphonurus* shows that these characters are variable within a species. Puthz (1977) describes only a light coloration of the body, but the long conservation in alcohol can make the maculation disappear. The locality, the biotope, the flight period and the penis shape are reliable criterions to identify our specimens as *S. lusoensis*.

GENERAL DISCUSSION

The Iberian Siphonuridae-fauna includes seven species at present. Six of these species have a limited distribution as shown in Fig. 1, but *S. lacustris* is widely distributed in Spain and Portugal.

The *aestivalis*-group is defined by Malzacher (1981) and Jacob (1968) as follows: larvae: 1) first two gills double, remaining five gills single, 2) second segment of maxillary palp provided on its inner margin with two rows of bristles of equal length, 3) tenth abdominal tergite with 2-4 stout spines on each postero-lateral margin, 4) spines on surface of tergites similar in length and width to spines on hind margins; male imago: 1) ninth abdominal tergite provided with long and pointed postero-lateral projections, 2) ventral sclerite of penis forming a tube, 3) lateral sclerite of penis rounded at apex, 4) transversal dorsal sclerite wider in the middle than at the sides. Therefore, the following Iberian species belong to the *aestivalis*-group: *S. hispanicus*, *S. ireneae*, *S. lusoensis* and *S. montanus*.

S. flavidus was included in the *aestivalis*-group by Jacob (1986), with the remark that the penis of *S. flavidus* is atypical for the group. Actually, the lateral sclerites are pointed at apex (Fig. 43). Furthermore, the ventral sclerites are so elongated that they reach the lateral sclerites (Fig. 43). The dorsal sclerite is much thinner and more pointed than in the other species of the *aestivalis*-group (Fig. 44). The larval sternites of *S. flavidus* (Figs. 17-18) have thin spines, longer than those on the hind margin of the tergites. In all the other species of the *aestivalis*-group, the spines on the sternites are shorter than those on the hind margin of the tergites (e.g. Figs. 12, 13, 27, 28, 39, 40). For these reasons, we leave open the question whether *S. flavidus* belongs to the *aestivalis*-group or not. Electrophoretical studies are currently being carried out in our laboratory for all the European species of Siphonuridae. These investigations, completed with morphological comparisons, will help to clarify the grouping of the *Siphonurus*-species. The eggs of *S. flavidus*, *S. hispanicus*, *S. montanus* and *S. lusoensis* were studied with Scanning Electron Microscopy. The structures of the chorion are very similar to those of the other *Siphonurus*-species presented by Studemann *et al.* (1988).

DETERMINATION OF THE LARVAE OF IBERIAN SIPHLONURIDAE

The larvae of all *Siphonurus*-species are very similar to each other. They can often be recognized by their ventral abdominal color pattern, but only in the last

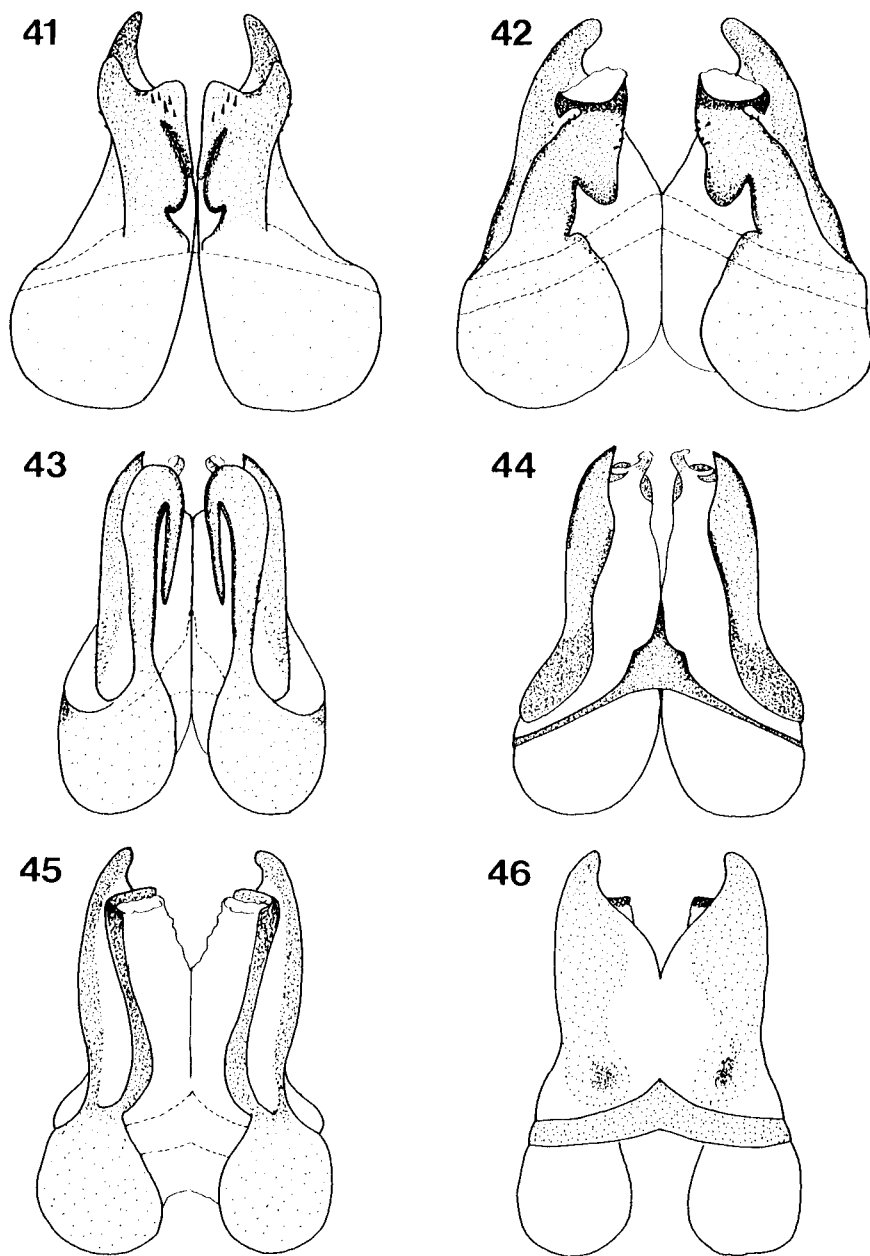

Fig. 41. *S. lacustris*. Fig. 42. *S. aestivalis*. Figs. 43-44. *S. flavidus*, Figs. 45-46. *S. ireneae*. Figs. 41, 42, 43, 45: penis, ventral view; figs. 44, 46: penis, dorsal view.

instar. Some species present a typical shape of the developing penis. We give here the morphological characters allowing a clear distinction of three species.

a) Tenth abdominal tergite without stout spines on the postero-lateral margins; spines on the surface of the tergites significantly smaller than those on the hind margin; second segment of maxillary palp provided on the inner margin with one row of long and one row of short thin bristles: *S. lacustris*.

b) Sternites provided with thin spines, longer than those on the hind margin of the tergites (Figs. 17-18); developing penis pointed at the apex (Fig. 16): *S. flavidus*.

c) Many strong spines on ventral side of the developing penis lobe (at least 12 on last larval skin), arranged in a bow (Fig. 26): *S. hispanicus*.

KEY TO THE MALE IMAGINES OF IBERIAN SIPHLONURIDAE

1. Ventral sclerite of penis flat and provided with a row of 3-5 strong spines (Fig. 41) ..*S. lacustris*
 – Ventral sclerite forming a tube 2
2. Lateral sclerite of penis pointed at the apex and with same length as the ventral sclerite (Fig. 43); transversal sclerite very narrow and very acute (Fig. 44)*S. flavidus*
 – Lateral sclerite of penis rounded at the apex and longer than the ventral sclerite
 *aestivalis*-group, 3
3. Penis provided with spines on the ventral sclerite 4
 – Penis without spines 5
4. Gonoporus provided laterally with a spherical pad directed ventrally (Fig. 21)*S. hispanicus*
 – Gonoporus without lateral pad (Fig. 42)*S. aestivalis*
5. Penis slightly sclerotinised ventrally, with a long and narrow ventral sclerite ending apically in one dorso-transversal bow (Figs. 45-46)*S. ireneae*
 – Penis strongly sclerotinised, ventral sclerite ending apically in two bows 6
6. Penis with apical bows of ventral sclerite dissimilar, the ventral one pointed, the dorsal one enlarged at apex and directed to the external part of penis lobe; bows joining laterally in a pad (Fig. 6)*S. montanus*
 – Penis with apical bows of ventral sclerite similar, both pointed at apex and directed to the internal part of penis lobe, no special joining of the bows (Fig. 33)*S. lusoensis*

ACKNOWLEDGEMENTS

We wish to thank Professor Dr. G. Lampel for his remarks concerning the manuscript. Dr. P. Malzacher, Dr. V. Puthz, Dr. U. Jacob, Dr. M. Sartori and Dr. D. Hefti are thanked for their helpful discussions. We are grateful to Dr. J. Alba-Tercedor who provided us with samples of *S. ireneae*. Mrs. L. Sygnarski, Mrs. S. Werhonig, Mr. H. Gachoud and Mr. R. Macherel are thanked for their technical assistance. This study was supported by the Swiss National Science Foundation (grant no 31-8857.86/4).

REFERENCES

- ALBA-TERCEDOR, J. (1981): Recopilacion de citas de efemeropteros en la Peninsula Iberica e Islas Baleares. – Trab. Monogr. Dep. Zool. Univ. Granada, 4: 41-81.

- (1984): A redescription of adults of *Siphonurus flavidus* (Pictet, 1865) (Ephemeroptera, Siphonuridae). – Proc. 4th Int. Confer. Ephemeroptera, Bechyne: 69-73.
- (1990): *Siphonurus ireneae* sp.n. from Spain (Ephemeroptera, Siphonuridae). – in I.C. Campbell ed. Mayflies and Stoneflies, Kluwer Academic Publishers, 323-326.
- DEMOULIN, G. (1958): Note sur quelques Ephéméroptères récoltés par M.G. Fagel en Estrémadure (mai 1958). – Bull. Anns Soc. r. Ent. Belg., 94: 261-264.
- EATON, A.E. (1870): On some new British species of Ephemeridae. – Trans. Ent. Soc. London: 1-8.
- (1871): A monograph on the Ephemeridae. – Trans Ent. Soc. London, 1:1-164.
- (1883-1888): A revisional monograph of recent Ephemeridae or mayflies. – Trans. Linn. Soc. London (zool.), 3: 1-352.
- (1903): A new species of Ephemeridae from Norway. – Ent. Mon. Mag., 2: 30-31.
- HEINZE, K. (1952): Polyvinyl-Lactophenol-Gemisch als Einbettungsmittel für Blattläuse. – Naturwissenschaften, 39: 285-286.
- JACOB, U. (1986): *Siphonurus abraxas* n.sp. – ein neues Taxon der *lacustris*-Gruppe aus Montenegro (Jugoslawien) (Ephemeroptera, Siphonuridae). – Reichenbachia, 23: 139-143.
- MALZACHER, P. (1981): Beitrag zur Taxonomie europäischer *Siphonurus*-Larven (Ephemeroptera, Insecta). – Stuttgarter Beitr. Naturkde., Ser. A, 345: 1-11.
- PARDO, I. (1990): Primera cita de *Siphonurus aestivalis* (Eaton, 1903) en la Peninsula Iberica (Ephemeroptera, Siphonuridae). – Bol. Asoc. Esp. Ent., 14: 274.
- PICTET, A.E. (1865): Synopsis des Névroptères d'Espagne. Genève, 123 p.
- PUTHZ, V. (1977): Bemerkungen über europäische *Siphonurus*-Arten (Ephemeroptera) – Reichenbachia, 16: 169-175.
- STUDEMANN, D., LANDOLT, P. and TOMKA, I. (1988): Morphology and taxonomy of imagines and eggs of Central and Northern European Siphonuridae (Ephemeroptera). – Bull. Soc. Ent. Suisse, 61: 303-328.