

CLADISTIC ANALYSIS OF THE *ULMERITUS-ULMERITOIDES* GROUP (EPHEMEROPTERA, LEPTOPHLEBIIDAE), WITH DESCRIPTIONS OF FIVE NEW SPECIES OF *ULMERITOIDES*

EDUARDO DOMÍNGUEZ¹

Department of Entomology, Cornell University, Ithaca, New York 14853

Abstract.—A cladistic analysis of the species of the genera *Ulmeritus* and *Ulmeritoides* is performed. Five new species of *Ulmeritoides* are described: *U. fidalgoi* n. sp. from male and female imagos and *U. misionensis* n. sp. from male and female imagos and nymphs from Argentina, *U. spinulipenis* n. sp. from male imagos from Uruguay, and *U. guanacaste* n. sp. and *U. tifferrae* n. sp. from male imagos and nymphs collected in Costa Rica. *U. flavopedes* is redescribed; *U. uruguayensis* (= *U. adustus* n. syn.), *U. luteotinctus* and *U. patagiatus* are discussed. The generic diagnosis of *Ulmeritoides* is modified to include all known species. Further evidence from the cladistic analysis supports the synonymy of *Pseudulmeritus* with *Ulmeritoides*, the monophyly of *Ulmeritus* and *Ulmeritoides*, and their status as sister groups.

The *Ulmeritus-Ulmeritoides* group is a very distinctive complex among the Leptophlebiidae. For a long time it was known only from a few species collected from NE Brazil, Uruguay and NW Argentina, with a single record from Suriname. New collections are now available to clarify the taxonomy and phylogeny of the group.

Ulmeritoides was established as a subgenus of *Ulmeritus* by Traver (1959) for *Ulmeritus (Ulmeritoides) uruguayensis* Traver, known from imagos of both sexes, and *U. (Ulmeritoides) luteotinctus* Traver, known only from female imagos. In 1960, Thew described *U. (Ulmeritoides) adustus* from imagos of both sexes and *Ulmeritus patagiatus* from subimagos, not assigning the last species to any subgenus. At that time, the only known nymph of *Ulmeritus* was that of *U. carbonelli* Traver.

In 1987 Savage suggested that *Ulmeritus* might be related to the *Hermanella* complex, but Flowers and Domínguez (1991) proposed a preliminary cladogram in which *Ulmeritus* and *Ulmeritoides* were more closely related to *Atopophlebia* and *Meridialaris*. A new species of the subgenus *Ulmeritoides* was reared for the first time and, based on the characteristics of both sexes, the subgenus was raised to full generic status (Domínguez, 1991).

In this paper I describe five new species of *Ulmeritoides* and discuss the species *U. uruguayensis*, *U. luteotinctus* and *U. patagiatus*. The species *U. adustus* is synonymized with *U. uruguayensis*, and *U. flavopedes* (Spieth) is redescribed. The generic diagnosis of *Ulmeritoides* is modified to include all known species and a phylogeny for the *Ulmeritus-Ulmeritoides* complex is reconstructed and discussed.

¹Permanent Address: CONICET-Facultad de Ciencias Naturales, Universidad Nacional de Tucumán; Miguel Lillo 205, 4.000 Tucumán, Argentina.

MATERIALS AND METHODS

Material from the following institutions was used: Universidad de la República, Montevideo, Uruguay (URU); Florida Agricultural and Mechanical University, Tallahassee, Florida, USA (FAMU), National Museum of Natural History, Smithsonian Institution, Washington, D.C., USA (NMNH), American Museum of Natural History, New York, USA (AMNH), Illinois Natural History Survey, Illinois, USA (INHS), Instituto Nacional de Biodiversidad, Costa Rica (INBio) and Instituto-Fundación Miguel Lillo, Tucumán, Argentina (IFML).

The phylogenetic relationships of the group were reconstructed with the aid of the Hennig86 (Farris, 1988) and CLADOS (Nixon, 1992) programs.

Genus *Ulmeritoides*

Ulmeritus (Ulmeritoides) Traver, 1959:8; Thew, 1960:125.

Ulmeritus (Pseudulmeritus) Traver, 1959:8.

Ulmeritoides; Domínguez 1991:160; Flowers and Domínguez, 1991:52.

Type species: *Ulmeritoides uruguayensis* (Traver), Original designation, as type species of *Ulmeritus (Ulmeritoides)*.

Species included: *U. luteotinctus* (Traver), *U. patagiatus* (Thew), *U. uruguayensis* (Traver), *U. flavopedes* (Spieth), *U. spinulipenis* new species, *U. fidalgoi* new species, *U. misionensis* new species, *U. tifferae* new species, *U. guanacaste* new species.

Distribution: From Costa Rica (11°N) to NE Argentina (27°S).

Discussion: This genus was characterized recently by Domínguez (1991) for both stages and sexes. With new material available, some modifications in the generic diagnosis are needed. 1) The development of the median denticle on the antero-median emargination of the labrum is not a constant character for the genus, but differs among species; 2) the generic description of the male genitalia should read: "Penis divided from the base, apex of penis lobes rounded to rather straight, with spines, small projections or with lateral groove"; 3) the posterolateral projections on abdominal segments VIII-IX (Fig. 2A) are of unusually large size for the family, presenting lateral spines. This character is also present in *Ulmeritus* species (Fig. 2B).

Material certainly belonging to this genus, but not assignable to any described species is given here to make distributional data available for further investigations: *Ulmeritoides* spp. (2 species): BRAZIL, Pará, Rio Xingú, Camp (52°22'W, 3°39'S) ca. 60 km S. Altamira. 8-16/X/1986. P. Spangler and O. S. Flint, Jr., Igarapé-Jabutí (2 female imagos, 2 male subimagos) (NMNH); *Ulmeritoides* sp. GUYANA: Mazaruni-Potaro District, Takutú Mountains (16°15'N, 59°5'W), 18/XII/1983, P. J. Spangler, W. E. Steiner and M. L. Levine. Earthwatch Expedition (1 nymph) (NMNH); *Ulmeritoides* sp. PARAGUAY: Paraguari, Depto Ybycui (25 km SE) in Ybycui National Park, 12-24/IV/1980, P. J. Spangler *et al.* (12 nymphs) (NMNH); *Ulmeritoides* sp. VENEZUELA: T. F. Amazonas, Puerto Ayacucho (40 km S) Tobogán, 19/II/86. P. J. Spangler, Col. # 1. (1 nymph) (NMNH); *Ulmeritoides* sp. GUATEMALA: 20 mi SW Puerto Barrios, 16/VIII/1965. P. J. Spangler (1 nymph) (NMNH); *Ulmeritoides* sp. FRENCH GUIANA: Sinnamary River, Saut Dalles Fleuve, 15/16/VI/92, V. Horeau (10 male subimagos, 3 female imagos, 2 female subimagos, 9 nymphs) (FAMU); Sinnamary River, Saut Maïpouri, 24-26/V/93, V. Horeau (1 female imago, 1 male subimago) (FAMU).

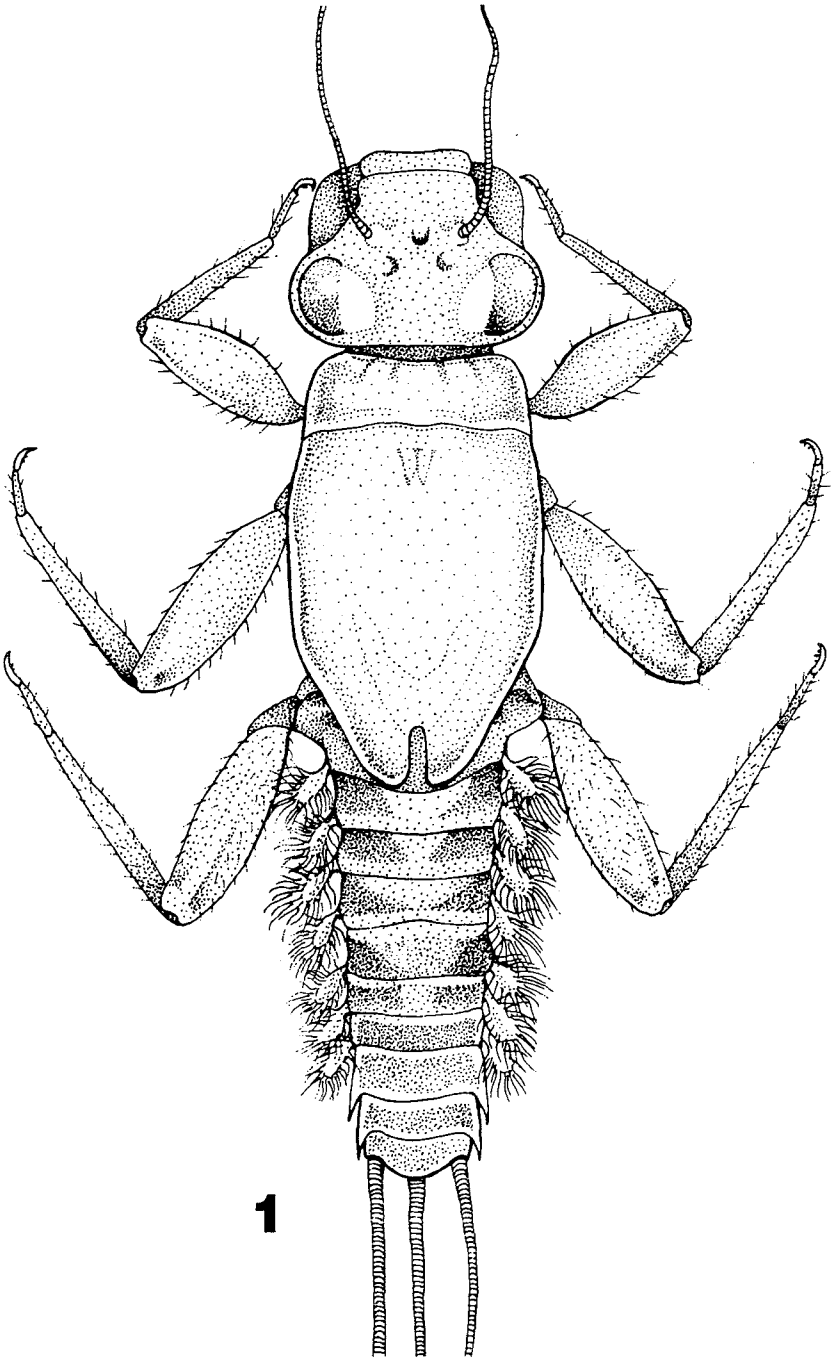

Fig. 1. *Ulmeritoides misionensis* nymph, dorsal view.

Key to the species of the genus *Ulmeritoides*

Male imagos

1. Forewings with costal and subcostal areas tinged with brown (Figs. 8A, 9A) 2
Forewings with costal and subcostal areas hyaline (Figs. 4A, 12A) 4
2. Apex of penis lobes straight, ending in an acute, apical projection (Fig. 8F, G); abdominal color pattern as in fig. 8D, E *U. misionensis* n. sp.
Apex of penis lobes more or less rounded, abdominal color pattern not as above 3
3. Longitudinal veins of forewings brownish, cross veins blackish; penis lobes with a shallow small prominence on outer margin, near apex (Fig. 9F, G) *U. tifferae* n. sp.
Veins C, Sc and R1 of forewings brown, remaining longitudinal veins yellowish, cross veins whitish; penis lobes with a small spine on ventral surface of outer corner (Fig. 7B, C) *U. fidalgoi* n. sp.
4. Apex of penis lobes rounded (Figs. 4F, 12G) 5
Apex of penis lobes not rounded (Figs. 5A, 6D) 6
5. Veins C, Sc and R1 of forewings yellowish; each penis lobe with a lateral groove (Fig. 4E, F) *U. flavopedes* (Traver)
Veins C, Sc and R1 of forewings yellowish, blackish the stigmatic area; each penis lobe with a small prominence on outer margin (Fig. 12G) *U. guanacaste* n. sp.
6. Penis lobes with apical margin ending in an acute projection (Fig. 5A)
. *U. uruguayensis* (Traver)
Penis lobes with several small spines on apical margin (Fig. 6D) *U. spinulipenis* n. sp.

Nymphs

1. Tibiae I with two black bands; medial denticle on anteromedian emargination of labrum much larger than the other four (Fig. 8H) *U. misionensis* n. sp.
Tibiae I almost completely washed with black, except base and apex lighter; medial denticle on anteromedian emargination of labrum subequal in size to other denticles (Fig. 10A, B) 2
2. Dorsum of femora II and III with numerous short, acute spines; femora II with a median black spot; abdominal color pattern as in Figure 9D *U. tifferae* n. sp.
Dorsum of femora II and III with a few short, blunt spines; femora II without a median black spot; abdominal color pattern as in Figure 12D *U. guanacaste* n. sp.

Ulmeritoides luteotinctus (Traver)

Ulmeritus (Ulmeritoides) luteotinctus Traver, 1959:11.

Ulmeritoides luteotinctus, Domínguez, 1991:162.

Discussion: Traver (1959) described this species based on female imagos and subimagos of both sexes. As the original description is adequate, I will not redescribe it. However, due to its different wing coloration, it is possible that the male subimagos do not belong in the same species. Within the paratypes, there are three that resemble the color pattern of *U. uruguayensis*.

U. luteotinctus can be separated from the other species of the genus by the following combination of characters: 1) forewings hyaline, veins orange-brown, lighter toward posterior margin; 2) abdominal terga and sterna yellowish, slightly tinged with brownish, posterior margin of each segment narrowly darker.

Material: Holotype female imago: URUGUAY, Artigas, Arroyo La Invernada, 21/II/54, C. S. Carbonell (URU). Paratypes: 7 female imagos, Timbauba, Arroyo Tres

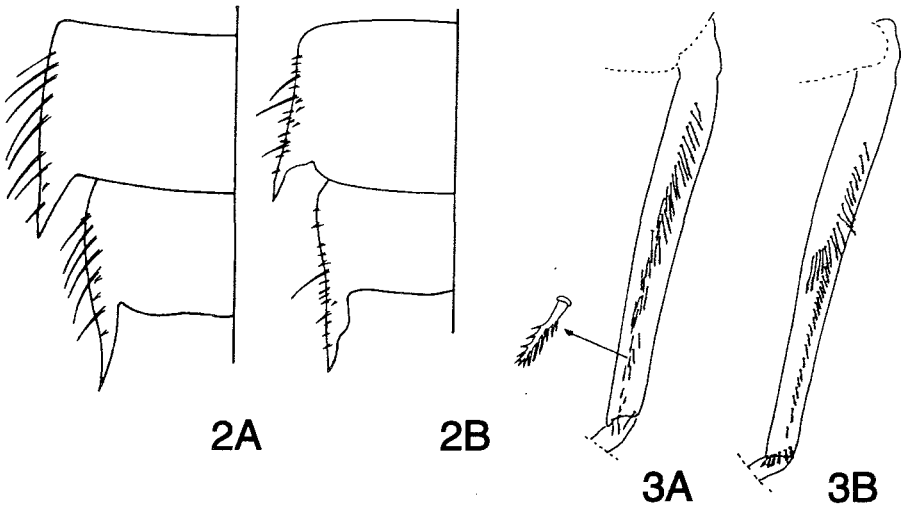

Figs. 2-3. Nymphs. 2, posterolateral projections on abdominal segments VIII-IX: A, *Ulmeritoides tifferae*; B, *Ulmeritus carbonelli*. 3, Detail of tibia III: A, *Ulmeritoides tifferae*; B, *Ulmeritus carbonelli*.

Cruces, 21/II/54, C. S. Carbonell (URU); idem, 1 female imago, 20/II/55; 1 female imago, Sepulturas, Picada del Negro Muerto, Rio Cuareim, 15/XII/57, C. S. Carbonell (URU). Also studied: 2 female imagos, 2 male subimagos, 1 female subimago, Cerro Largo, Arroyo Quebracho (curso superior), 4-8/III/59, C. S. Carbonell (URU); 1 male subimago, Tacuarembó, Tacuarembó Chico, 20/I/60, C. S. Carbonell (URU).

Ulmeritoides flavopedes (Spieth)

Thraulodes flavopedes Spieth, 1943:11.

Atalophlebioides flavopedes, Traver, 1946:426.

Ulmeritus (Pseudulmeritus) flavopedes, Traver, 1959:8.

Ulmeritoides flavopedes, Domínguez, 1991:162.

Holotype male imago (pinned, one pair of wings and genitalia mounted on slides). Length: body, 6.6-6.7 mm; forewings, 8.0-8.1 mm; hind wings, 1.5-1.6 mm. General coloration bright orange-brown. Wings hyaline. *Head* light brown. Upper portion of eyes orange-brown, lower portion blackish. Antennae: scape and pedicel brownish, flagellum lighter. *Thorax*: pronotum light brown, with posterior margins black; mesonotum, pleura and sterna bright orange, carinae darker; metanotum light orange, weakly washed with black. *Wings* (Fig. 4A, C): membrane of both wings hyaline, wing bases brown. Veins C, Sc and R1 yellowish, remainder hyaline. *Legs*: Leg I brown, except apex of tibiae and tarsi I yellow, tarsomeres II-V grayish; tarsal claws orange. Legs II-III yellowish except coxae, trochanters, base and median band on femora brownish. *Abdomen* (Fig. 4D): terga orange-brown with posterior margins blackish. Sterna grayish-orange. *Genitalia* (Fig. 4E, F): Apex of penis lobes rounded, each with a lateral groove (colors faded).

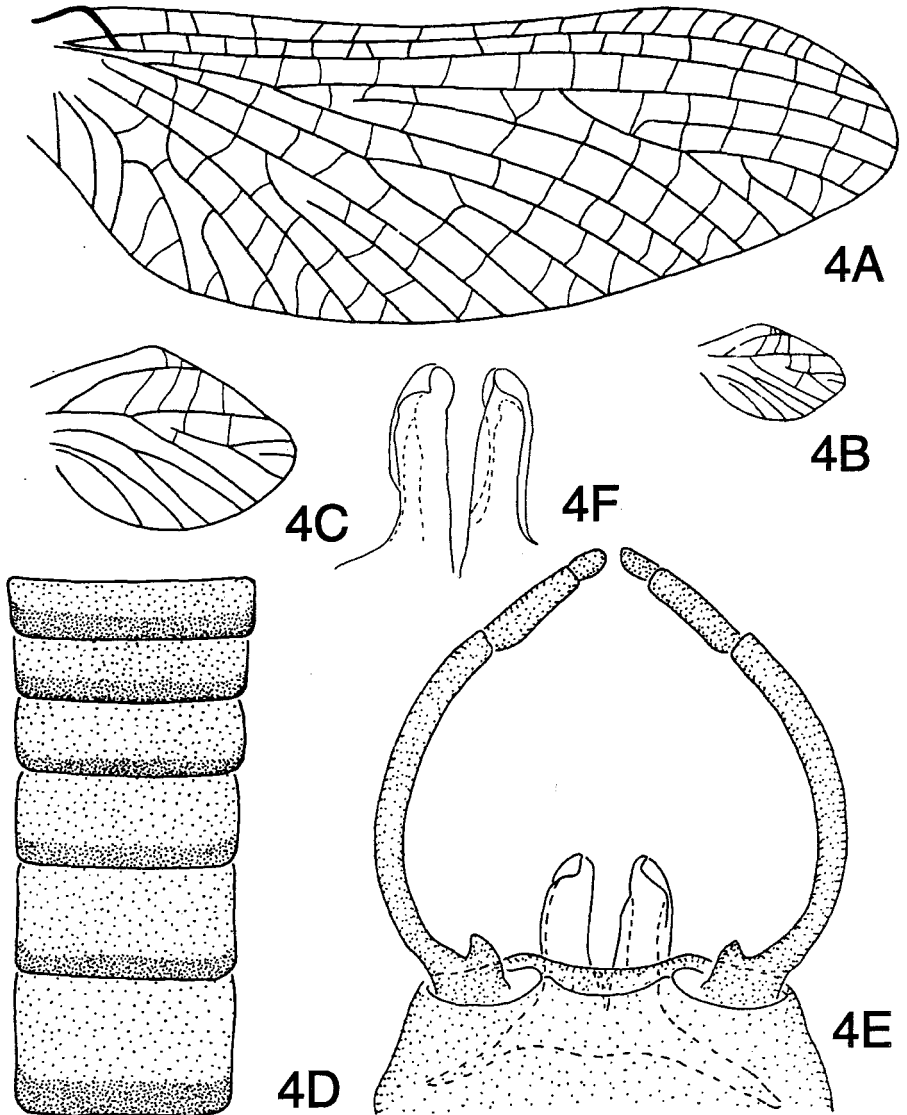

Fig. 4. *Ulmeritoides flavopedes*. Male imago. A, forewing; B, hind wing; C, hind wing enlarged; D, abdominal terga II-VII; E, genitalia (ventral view); F, penis lobes (ventral view, enlarged).

Material: Holotype male imago: SURINAM, Moengo, 12/IV/1939, D. C. Geijskes col (AMNH). Paratype: SURINAME, Litani river, Feti Creek, 17/VII/1939, D. C. Geijskes (AMNH).

Discussion: Traver (1959) established the subgenus *Pseudulmeritus* for this single species. When I elevated *Ulmeritoides* to the generic level (Domínguez, 1991) I tentatively included *U. flavopedes*. Based on the phylogenetic relationships of *Ulmeritoides* species, this placement is confirmed (see discussion under phylogeny).

Ulmeritoides patagiatus (Thew)

Ulmeritus patagiatus Thew, 1960:128.

Ulmeritoides patagiatus, Domínguez, 1991:162.

Discussion: Thew (1960) described this species based on subimagos of both sexes, not assigning it to any subgenus. After studying the type material it is clear that this species belongs in *Ulmeritoides* (Domínguez, 1991); however, until imagos of this species are obtained it cannot be redescribed or synonymized.

Material: Holotype male imago and Allotype female imago: BRAZIL, Santa Catarina, Nova Teutonia, F. Plaumann, IX/1956 (INHS).

Ulmeritoides uruguayensis (Traver)

Ulmeritus (Ulmeritoides) uruguayensis Traver, 1959:8.

Ulmeritoides uruguayensis, Domínguez, 1991:162.

Ulmeritus (Ulmeritoides) adustus Thew, 1960:126. **NEW SYNONYMY.**

Discussion: This species was adequately described by Traver (1959). I include an illustration of the penis, because they can be of use for the identification of this species. The abdominal color pattern and the wings are very similar to *Ulmeritoides spinulipenis*.

Ulmeritus (Ulmeritoides) adustus is a synonym of *U. uruguayensis*. In his original description, Thew (1960) indicated as diagnostic characters for this species two small spines on the penis lobes, and the abdominal and leg coloration. I had the opportunity to study the types and I did not find any difference between the genitalia of *U. adustus* and *U. uruguayensis*. Also, the coloration fits within the intraspecific variation of *U. uruguayensis*.

Ulmeritoides uruguayensis can be separated from the other species of the genus by the following combination of characters: 1) forewings hyaline, brown spot at base; 2) abdominal color pattern similar to that in Figure 6B; 3) 7-8 cross veins basal to bulla in forewings; 4) penis as in Figure 5A.

Material: Holotype male imago: URUGUAY, Artigas, Arroyo de la Invernada, C. S. Carbonell, 21/II/54 (URU). Paratypes: 2 male imagos, 20 female imagos, 30 male subimagos, 15 female subimagos (idem Holotype); 1 male imago, 15 female imagos, 3 male subimagos, 4 female subimagos, Sepulturas, Rio Cuareim, C. S. Carbonell, 13/II/52 (URU). Other material: 40 male subimagos, 5 female subimagos, Cerro Largo, Arroyo Quebracho (Curso Superior), C. S. Carbonell, 4-8/III/59 (URU); 1 female subimago, Tacuarembó, Valle Edén, F. Achaval, IV/80 (URU). Also studied: *U. (U.) adustus*, Holotype and Allotype: BRAZIL, Santa Catarina, Nova Teutonia, F. Plaumann, II/57 (INHS).

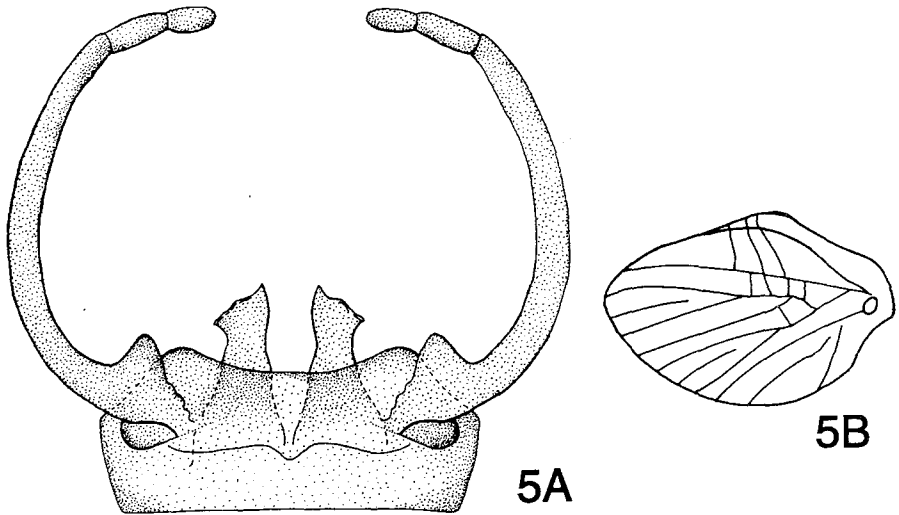

Fig. 5. *Ulmeritoides uruguayensis*. Male imago. A, genitalia (ventral view); B, hind wing.

Ulmeritoides spinulipenis, new species

Holotype male imago (in alcohol). Length: body, 7.0–7.3 mm; forewings, 7.2–7.5 mm; hind wings, 1.4–1.5 mm. General coloration orange-brown, abdomen lighter. *Head* whitish, diffusely washed with black. Upper portion of eyes reddish-brown, lower portion blackish. Ocelli white, ringed with black at base. Antennae light orange, flagellum lighter. *Thorax*: pronotum light orange-brown with lateral and posterior margins and paramedian areas grayish, median area blackish; mesonotum bright orange-brown, carinae darker; metanotum grayish-brown; pleura brownish, with white spots close to wing bases; sterna light-brown, darker in median area. *Wings* (Fig. 6A): membrane of forewings hyaline, light brown at base, stigmatic area translucent, three small spots, one on bulla and others two in line with it on the next two veins; veins whitish, except apical $\frac{1}{2}$ of C, Sc and R1 brownish; 9–10 cross veins basal to bulla. Membrane of hind wings hyaline (Fig. 6A), brown spot at base; veins C and Sc yellowish, remaining veins whitish. *Legs*: Leg I orange-brown, washed with black on coxae and trochanters and on external side of femora; narrow black band located at $\frac{2}{3}$ apical of femora, tibiae blackish except basal part orange-brown and distal part whitish; tarsi yellowish; legs II and III yellowish, washed with black on coxae and trochanters; two narrow black bands on femora, one on apical $\frac{2}{3}$ and the other on apex. *Abdomen* (Fig. 6B): terga brownish-yellow, terga I–III almost completely washed with black, remaining segments with black markings enclosing a lighter central area, tergum X yellowish; sterna yellowish, diffusely washed with black. *Genitalia* (Fig. 6C, D): bright orange-brown, forceps orangish, paler toward apex. Penis whitish with small spines as in Figure 6D. Caudal filaments whitish, with black rings at each intersegmental joint, alternating one wide and one narrow.

Female and nymph: Unknown.

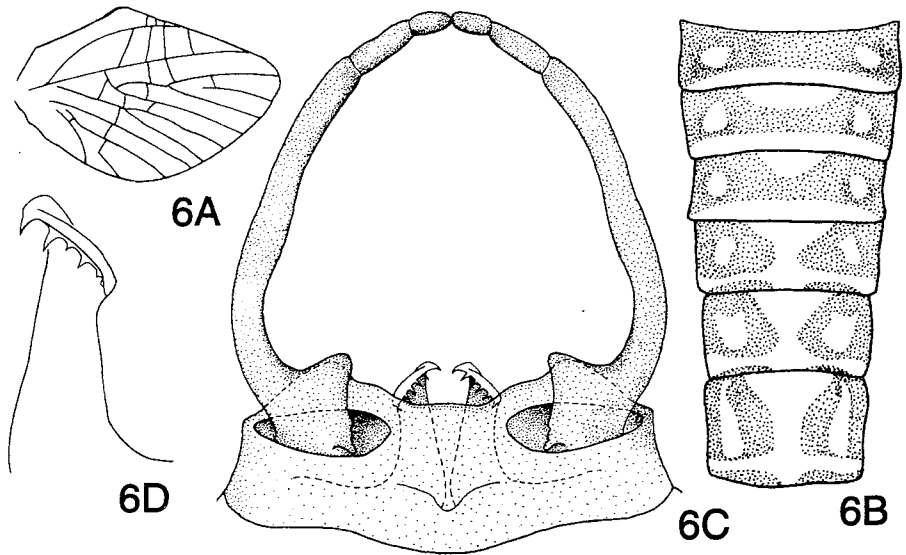

Fig. 6. *Ulmeritoides spinulipenis*. Male imago. A, hind wing; B, abdominal terga II-VII; C, genitalia (ventral view); D, penis lobe (ventral view, enlarged).

Material: Holotype male imago: URUGUAY, Tacuarembó, Tacuarembó chico, C. S. Carbonell, 20/I/1960 (URU). Paratypes: 2 male imagos (idem holotype) (IFML). Other material: 2 male subimagos, Paysandú, Santa Rita, C. S. Carbonell et al. 20/I/62 (URU); 1 male subimago, ARGENTINA, Misiones, Puerto Libertad, O. S. Flint, Jr., 24/XI/73 (USNM).

Etymology: *L. spinula*, meaning small spine, and *L. penis*, penis.

Discussion: *Ulmeritoides spinulipenis* can be separated from the other species of the genus by the following combination of characters: 1) forewings hyaline, with three small spots, one on the bulla and the other two in line with it on the next two veins; 2) abdominal color pattern as in Figure 6B; 3) 9-10 cross vein basal to bulla in forewings; 4) penis lobes with small spines as in Figure 6D.

Biology: Unknown.

Ulmeritoides fidalgoi, new species

Holotype male imago (in alcohol, genitalia on slide). Length: body, 6.5-7.2 mm; forewings, 8.0-8.5 mm; hind wings, 1.6-1.9 mm. General coloration: orange-brown, abdomen washed with black. *Head:* whitish, with anterior margin and lines between ocelli black. Upper portion of eyes orange-brown, lower portion blackish. Ocelli white, base black. Antennae: scape and pedicel orange-brown [flagellum broken off and lost]. *Thorax:* pronotum light-orange-brown, with lateral margins and median and paramedian areas blackish; mesonotum light yellow-brown, margins and carinae darker; metanotum light brown, washed with black; pleura orange-brown, with margins of sclerites washed with black; sterna bright orange-brown, washed with black

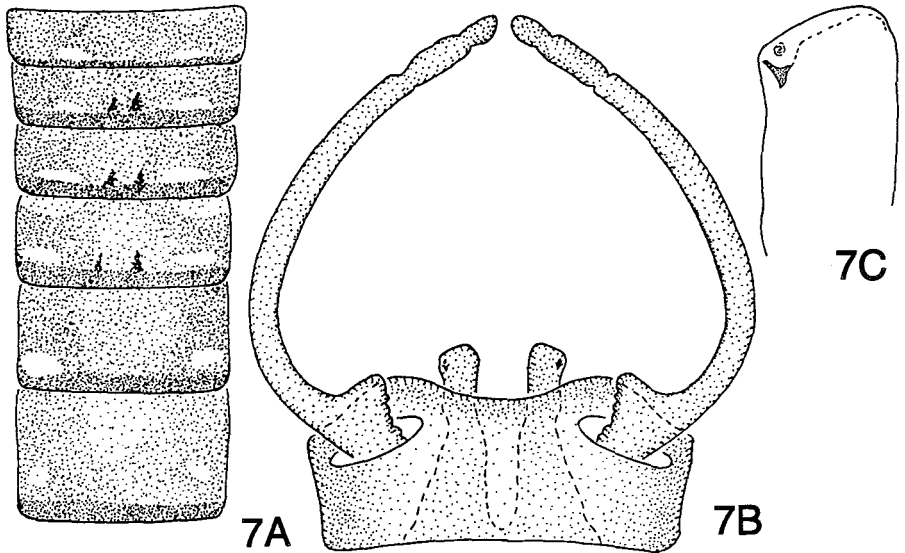

Fig. 7. *Ulmeritoides fidalgoi*. Male imago. A, abdominal terga II-VII; B, genitalia (ventral view); C, penis lobe (ventral view, enlarged).

in central area. *Wings*: membrane of forewings hyaline, costal and subcostal areas brown, paler toward apex, wing base brown. Veins C, Sc and R1 and cross-veins between them brownish; remaining longitudinal veins yellowish, cross veins whitish; 8-10 cross veins basal to bulla. Membrane of hind wings hyaline, brown spot at base; longitudinal and cross veins in costal area light brown, darker at base, remaining veins yellowish, lighter toward hind margin. *Legs*: coxae and trochanters orange-brown; femora light brown, femora I and II with medial and apical black spots; femora III with basal half, median band and apex blackish; tibiae yellowish, tarsi I-IV yellowish washed with gray, tarsi V and claws grayish-black. *Abdomen* (Fig. 7A): terga brown-orange, with black markings as in Figure 7A; markings darker in the first segments, paler toward the last ones; sterna orange-yellowish, washed with brown. *Genitalia* (Fig. 7B, C): subgenital plate and base of forceps light brown, remainder of forceps and penis yellowish. Each penis lobe with a small spine close to the outer corner (Fig. 7C). [Caudal filaments broken off and lost].

Allotype female imago (In alcohol). Length: body, 7.3-7.8 mm; forewings, 10.5-11.0 mm; hind wings, 1.9-2.2 mm. Similar to holotype except as follows: head light yellow, posterior margin blackish; eyes black; pronotum yellowish; mesonotum bright yellow; abdomen light grayish-brown, pattern paler.

Nymph: Unknown.

Material: Holotype male imago: ARGENTINA, Misiones, Bompland (Camping), Arroyo Martires, 26/XI/86, E. Domínguez col. (IFML); Allotype female imago, same data as holotype. Paratypes: 2 male imagos, 10 female imagos, 1 male subimago, same data as holotype; 2 female imagos, 1 male subimago, same data as holotype, except collected 15/II/85; 1 female subimago: Misiones, Arroyo Pepiri Mini (De-

sembocadura Rio Uruguay) 1/XII/86, E. Domínguez col. All material deposited in IFML, except 10 female imagos, 5 in (FAMU) and 5 in (NMNH).

Etymology: I name this species after my friend, the chalcidologist A. A. P. Fidalgo, with whom I was traveling when I collected this species.

Variation: In some females the mesonotal and abdominal color pattern is much paler than in the allotype.

Discussion: *Ulmeritoides fidalgoi* can be separated from the other species of the genus by the following combination of characters: 1) forewings hyaline, with costal and subcostal areas tinged with brown; 2) abdominal color pattern similar to the one in Figure 7A; 3) 8–11 cross veins basal to bulla of forewings; 4) penis as in Fig. 7B, C.

Biology: Unknown.

Ulmeritoides misionensis, new species

Ulmeritoides sp. Domínguez, 1991:166, figures. 18–29.

Holotype male imago (in alcohol, one pair of wings and genitalia on slides.) Length: body, 7.9–8.2 mm; forewings, 9.2–9.6 mm; hind wings, 1.8–2.0 mm. General coloration yellow-brown, abdomen washed with black. *Head:* light yellow, with median line and anterior margins washed with black. Upper portion of eyes light-brown, lower portion blackish. Ocelli white, black basally. Antennae: scape and pedicel orange-brown, flagellum yellowish, washed with black. *Thorax:* pronotum light brown with lateral, posterolateral and medial and paramedian areas blackish; mesonotum light yellow-brown, margins and carinae darker; metanotum light brown, washed with black; pleura yellow-brown, washed heavily with black; pro- and metasternum light brown, heavily washed with black, mesosternum yellowish, tinged with black in median area. *Wings* (Fig. 8A, C): membrane of forewings (Fig. 8A) hyaline, costal and subcostal areas light brown, stigmatic area much lighter, wing base light brown. Veins C, Sc and R1 and cross veins between them brownish; remaining veins whitish; 10 cross veins basal to bulla. Membrane of hind wings hyaline, brown spot at base (Fig. 8B, C); basal portion of vein Sc brownish, remaining veins whitish. *Legs:* coxae and trochanters light brown, heavily washed with black; femora I light brown with a black spot at mid-length and washed with black in basal half of apex; tibiae I light brown with a subbasal and a subapical black band; femora II yellowish with a black spot a little apically of median area; femora III yellowish with a black mark in median area and washed with black in basal 1/2 and apex; tibiae II and III yellowish-white; tarsi of all legs light yellow washed with gray; claws grayish-black. *Abdomen* (Fig. 8D, E): terga yellow-brown, with black markings covering posterolateral angles, lateral margins and delimiting a circular area lighter, as in Figure 8D; sterna light brown, heavily washed with brown on the anterior segments, lighter posteriorly. *Genitalia* (Fig. 8F, G): yellowish-brown, washed with black mainly in subgenital plate and apical 4/5 of forceps segment I. Apex of penis lobes straight, ending in an acute apical projection (Fig. 8G). Caudal filaments whitish, with black rings at each intersegmental joint, alternating one wide and one narrow. *Female subimago* (in alcohol). Length: body, 7.0–8.0 mm; forewings, 11.0–11.5 mm; hind wings, 2.0–2.2 mm. Coloration as in male imago, except: head yellowish-white, posterior margin blackish; wing membrane translucent, tinged with yellowish-brown,

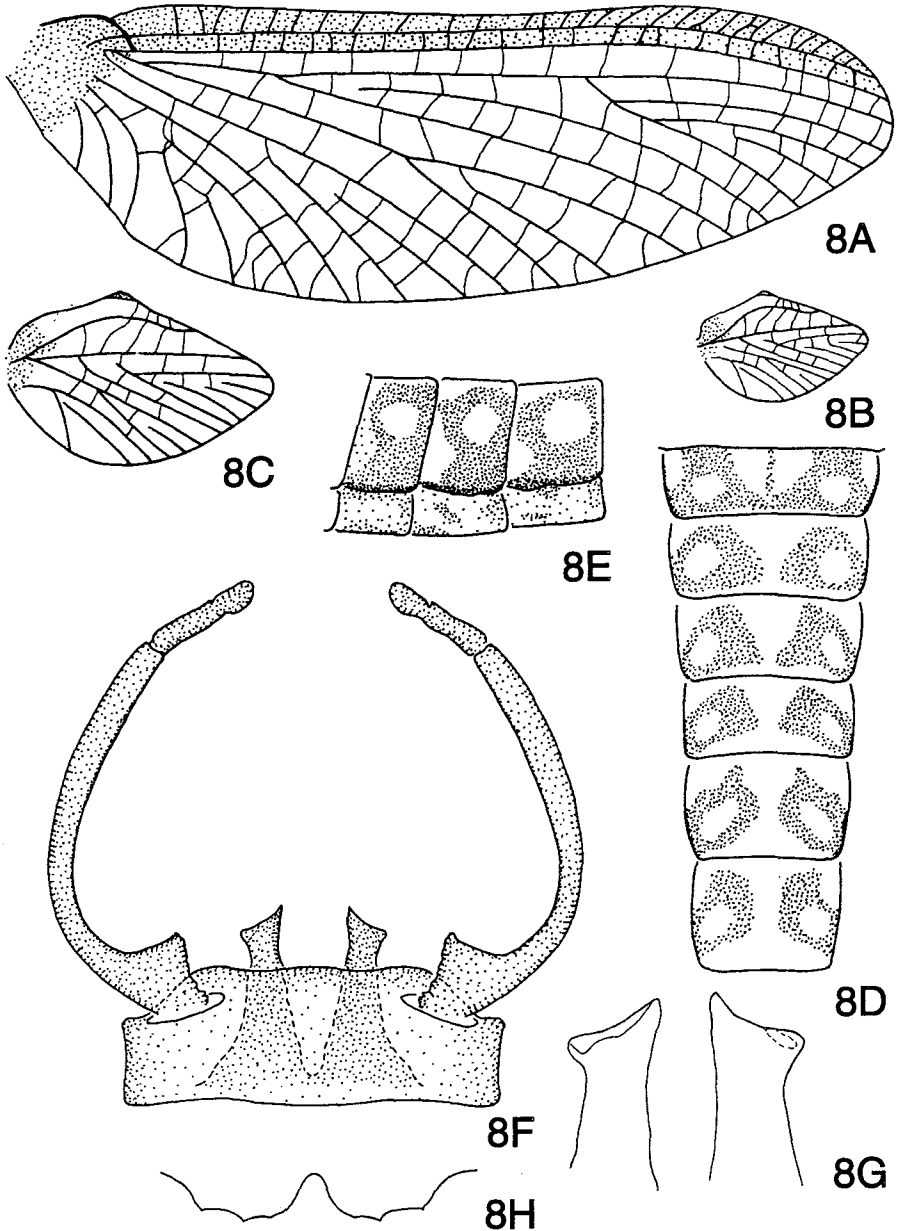

Fig. 8. *Ulmeritoides misionensis*. Male imago (A-G), Nymph (H). A, forewing; B, hind wing; C, hind wing enlarged; D, abdominal terga II-VII; E, abdominal segments V-VII, lateral view; F, genitalia (ventral view); G, penis lobes (ventral view, enlarged); H, detail of anteromedian emargination of labrum.

except costal and subcostal areas brownish; abdominal markings less marked than in male imago.

Mature nymph (in alcohol) (Fig. 1). Body length, 7.0–8.8 mm. General coloration: bright orange-brown with black markings. *Head*: light orange-brown with central area and between ocelli and eyes yellowish. Ocelli whitish with inner margins black. Eyes of male with upper portion reddish-brown, lower portion black. Eyes of female black. Antennae: scape and pedicel light brown, flagellum yellowish, paler toward apex. *Mouthparts*: clypeus, labrum, basal 2/3 of mandibles, basal 1/2 of maxillae and segment I of palpi and labium brownish, remaining parts lighter. Medial denticle on anteromedian emargination of labrum much larger than others (Fig. 8H). Tusk on inner apical margin of maxillae of medium size, similar to Figure 10C. *Thorax*: nota bright orange-brown, with black markings as in male imago, medial line yellowish, pleura and sterna yellowish-brown, washed with black as in male imago. *Legs*: light brown, with coxae washed with black and black markings as in male imago, but smaller; numerous short, pointed spines on dorsum of femora II–III. Claws light brown, apex orangish. *Abdomen*: terga bright orange-brown, darker posteriorly, black markings as in male imago; sterna yellowish washed with black, darker anteriorly. Gills yellowish, trachea and fimbriae blackish. Caudal filaments brownish lighter toward apex.

Material: Holotype, male imago, ARGENTINA, Misiones, Inta San Vicente, 30/XI/86, E. Domínguez col. (IFML); Paratypes: 1 male imago, 1 male subimago, 3 female subimagos, 40 nymphs. All deposited at IFML, except 10 nymphs in (FAMU) and 10 nymphs in (NMNH). The association of the adult and nymphs was made from rearing by E. Domínguez.

Etymology: *misionensis*, from Misiones Province, Argentina, where this species was collected.

Variation: The male paratype color is lighter than in the holotype, especially in the abdominal pattern.

Discussion: The nymph of *U. misionensis* was used to characterize *Ulmeritoides* (Domínguez, 1991) and all illustrations referred to as "*Ulmeritoides* sp." are of this species.

Ulmeritoides misionensis can be separated from the other species of the genus by the following combination of characters. In the imagos: 1) forewings (Fig. 8A) hyaline, with costal and subcostal areas light brown, stigmatic area much lighter; 2) abdominal color pattern as in Figure 8D, E; 3) 10 cross veins basal to bulla in forewings; 4) penis as in Figure 8F, G. In the nymph: 1) medial denticle on anteromedian emargination of labrum much larger than others (Fig. 8H); 2) tibiae I with subbasal and subapical black bands; 3) dorsum of femora II–III with numerous short, pointed spines; 4) femora II with median black spot.

Ulmeritoides tifferae, new species

Holotype male imago (in alcohol). Length: body, 6.8–7.2 mm; forewings, 8.0–8.2 mm; hind wings, 1.9–2.0 mm. General coloration: brownish, abdomen slightly washed with black. *Head*: light orange, heavily washed with black. Upper portion of eyes yellow-brown, lower portion blackish. Ocelli white, heavily washed with brown laterally, blackish basally. Antennae: scape and pedicel light brown, flagellum

lighter. *Thorax*: pronotum light brown, heavily tinged with black on lateral and posterior margins, median and paramedian areas blackish; mesonotum light orange-brown, margins and carinae darker; metanotum light brown, washed with black; pleura light brown, with margins of sclerites darker; sterna orange-brown, washed with black. *Wings* (Fig. 9A–C): membrane of forewings (Fig. 9A) hyaline, costal and subcostal areas light brown, wing base brown; longitudinal veins brownish, cross veins blackish, both lighter toward hind margin; 5 cross veins basal to bulla. Membrane of hind wings (Fig. 9B, C) hyaline, tinged with brown in costal area, brown spot at base; longitudinal and cross veins in costal area brownish, darker at base, remaining veins yellowish toward hind margin. *Legs*: coxae brownish, washed with black; trochanters light brown; femora light brown with apical and medial black spot except in femora III where black spot almost joins black stain in basal half; tibiae I blackish, base lighter; tarsi and claws in fore leg yellowish washed with black; tibiae and tarsi I–IV in legs II and III yellowish, tarsi V and claws yellowish washed with black. *Abdomen* (Fig. 9D, E): terga light brown washed with black; sterna lighter. *Genitalia* (Fig. 9F, G): subgenital plate, penis and base of forceps segment I light brown, distal part of forceps segment I and segments II and III washed with black. Apex of penis lobes rounded, each with a shallow small prominence on outer margin (Fig. 9G). Caudal filaments light brown, washed with black.

Female imago: Unknown.

Mature nymph (in alcohol). Body length, 7.0–8.0 mm. General coloration: light orange-brown with areas between ocelli and eyes heavily tinged with black. Ocelli whitish with inner margins black. Eyes of male with upper portion orange-brown, lower portion black. Eyes of female black. Antennae: light yellow, paler toward apex. *Mouthparts*: clypeus, labrum, basal 2/3 and base of molars of mandibles, basal 1/2 of maxillae and segment I of palpi and labium light brown, molars and incisors of mandibles and setae on galea-lacinia of maxillae orange-brown, remaining parts lighter. Denticles on anteromedian emargination of labrum subequal (Fig. 10A, B). Tusk on inner apical margin of maxillae of medium size (Fig. 10C). *Thorax*: terga yellow-brown, with irregular black markings especially on the lateral margins, sterna and pleura light yellow. *Legs*: light brown, with coxae washed with black, apical and median blackish spots on femora, inner margin of tibiae blackish, narrow median band on tarsi dark brown; numerous short, pointed spines on dorsum of femora II–III. Claws light brown, apex orange-brown. *Abdomen*: terga light orange-brown, with black markings as in male imago; first sterna yellowish, last orangish. Gills whitish, trachea and fimbriae gray-violet. Caudal filaments bright orange-brown.

Female imago: Unknown.

Material: Holotype, Male imago: COSTA RICA, Guanacaste, Quebrada Alcornoque, Cerro El Hacha, Parque Nacional Guanacaste, 18/VII/1989, C. de La Rosa Col (INBio). Paratypes: 6 Male imagos, same data as holotype, 2 in (INBio), 2 in (FAMU) and 2 in (IFML); 18 nymphs, same data as holotype except data: 26/V/91, R. Tiffer and R. W. Flowers col., 10 in (INBio), 4 in (FAMU) and 4 in (IFML). The association of the adults and nymphs was made by the abdominal color pattern, from material collected at the type locality.

Etymology: This species is dedicated to Miss Ruth Tiffer S., former "Research Coordinator of the Guanacaste Conservation Area," who was one of the collectors of the nymphs of this species.

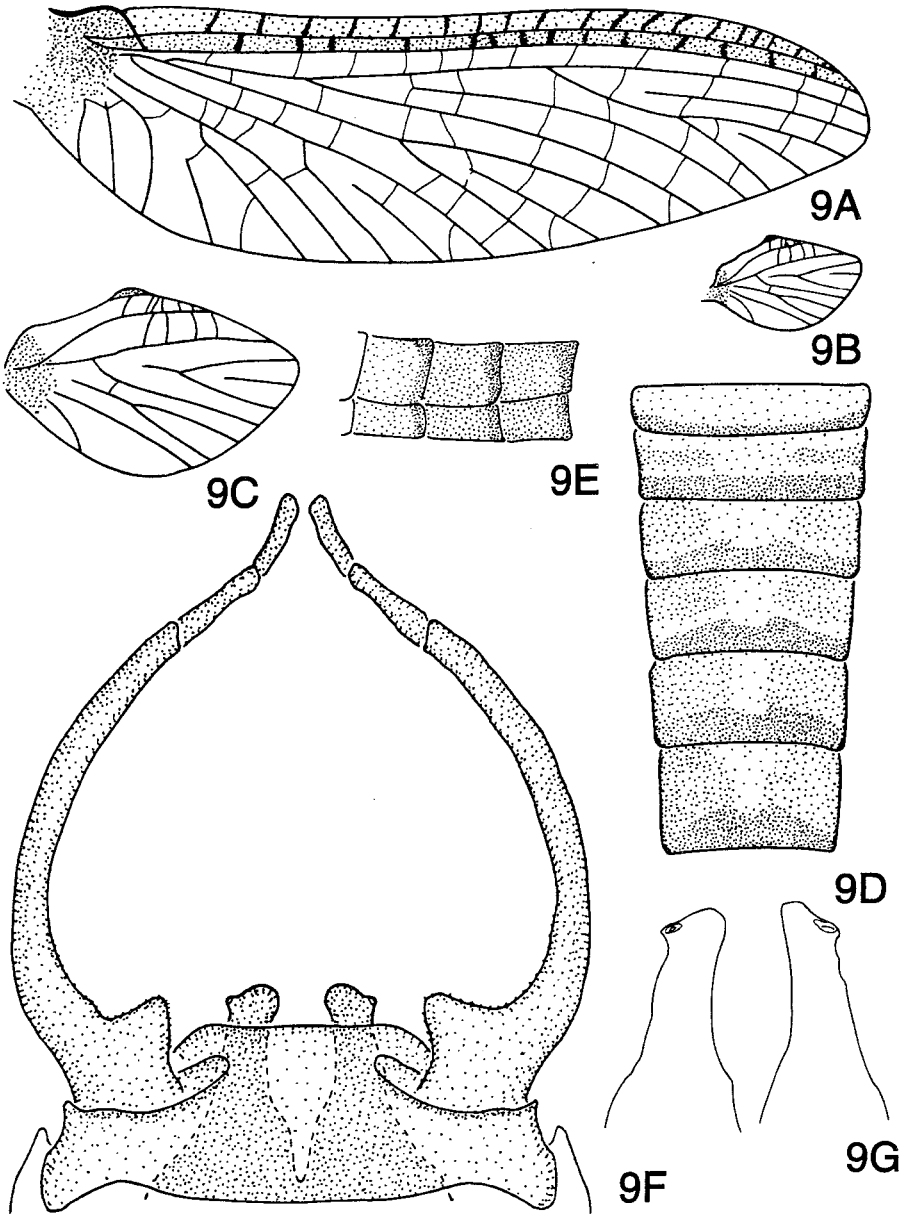
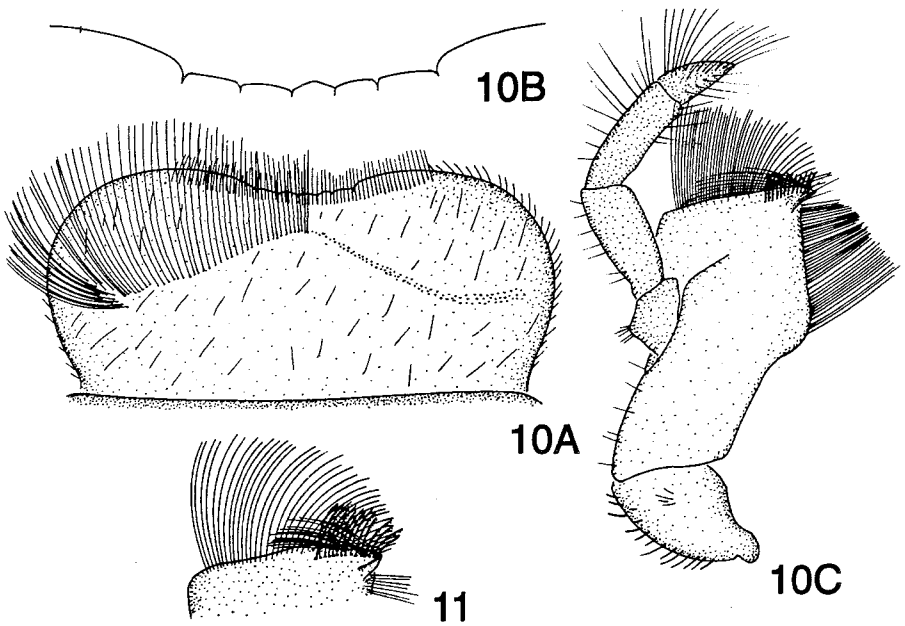

Fig. 9. *Ulmeritoides tifferae*. Male imago. A, forewing; B, hind wing; C, hind wing enlarged; D, abdominal terga II-VII; E, abdominal segments V-VII, lateral view; F, genitalia (ventral view); G, penis lobes (ventral view, enlarged).



Figs. 10–11. Nymphs. 10. *Ulmeritoides tifferae*. A, labrum (dorsal view); B, labrum (detail anteromedian emargination); C, right maxilla. 11. *Ulmeritoides guanacaste*, apex of right maxilla.

Variation: One of the paratypes has more extensive black markings on the fore legs; some of the nymphal legs are light yellow and the size of the tibial spot varies slightly.

Discussion: *U. tifferae* can be differentiated from the other species of the genus by the following combination of characters. In the imagos: 1) forewings hyaline, with costal and subcostal areas tinged with brown (Fig. 9A); 2) abdominal color pattern as in Fig. 9D, E; 3) 5 cross veins basal to bulla in forewings; 4) penis as in Figure 9F, G. In the nymph: 1) denticles on anteromedian emargination of labrum subequal (Fig. 10B); 2) tibiae I almost completely tinged with black; 3) dorsum of femora II–III with numerous short, pointed spines; 4) femora II with a median black spot.

Biology: Nymphs were collected from leaf packs and wood in a pool area of Quebrada Alcornoque.

Ulmeritoides guanacaste, new species

Holotype male imago (in alcohol, one pair of wings and genitalia on slides). Length: body, 7.2–7.5 mm; forewings, 7.6–7.8 mm; hind wings, 1.2–1.3 mm. General coloration: brownish, abdomen tinged with black. *Head:* orange-brown washed with black on anterior margins. Upper portion of eyes brownish-yellow, lower portion grayish-black. Ocelli white, ringed with black at base. Antennae: scape and pedicel yellowish, flagellum lighter.

Thorax: pronotum orange-brown with lateral and posterior margins and median and paramedian areas blackish; mesonotum bright orange-brown, margins and carinae darker; metanotum light brown; pleura light brown, with margins of sclerites darker; sterna orange-brown, washed with black. *Wings* (Fig. 12A–C): membrane of forewings (Fig. 12A) hyaline, light brown at base, stigmatic area translucent; veins C, Sc and R1 yellowish, except blackish in stigmatic area, remaining longitudinal veins whitish, except distal portions of veins Rs and MA tinged with black; cross veins in stigmatic area blackish, remaining cross veins whitish; no cross veins basal to bulla. Membrane of hind wings (Fig. 12B, C) hyaline, brown spot at base, veins C, Sc and cross veins in costal area grayish, remaining veins whitish. *Legs*: foreleg: coxae and trochanters brown, washed with black; femora light brown with a spot on apical 2/3 and apex blackish; tibiae almost completely black, except little portion at base and apex, brownish; tarsi and claws grayish-brown, washed with black; legs II and III: coxae brown, washed with black; trochanters light brown; femora II light brown with apex blackish, femora III with basal 2/3 washed with black; tibiae and tarsi yellowish washed with black; claws grayish. *Abdomen* (Fig. 12D, E): terga brownish, washed with black, especially along median-dorsal line as in Figure 12D; sterna marking similar to those of terga but with ganglial areas darker. *Genitalia* (Fig. 12F, G): subgenital plate, penis and basal 1/5 of segment I and segments II and III of forceps light brown, apical 4/5 of forceps segment I blackish. Apex of penis lobes rounded, with a small prominence on outer margin (Fig. 12G). Caudal filaments gray-yellowish.

Female imago: Unknown.

Mature nymph (in alcohol, mouthparts on slide). Body length, 5.1–5.2 mm. General coloration: bright orange-brown, with black markings. *Head*: yellowish-brown, washed with black. Ocelli whitish with inner margins black. Eyes of male with upper portion bright orange-brown, lower portion black. Eyes of female black. *Antennae*: scape and pedicel light yellow, flagellum whitish. *Mouthparts*: light brown except wide V shape mark that starts on clypeus and ends close to the anterior margin of labrum, base and inner 2/3 of mandibles, basal 2/3 of maxillae and maxillary palpi and mentum and base of paraglossae and base of labial palpi segment I washed with black, molars and incisors of mandibles and setae on galea-lacinia of maxillae orange-brown. Denticles on anteromedian emargination of labrum subequal in size. Tusk on inner apical margin of maxillae very small (Fig. 11). *Thorax*: nota light-brown, with black markings as in male imago, pleura and sterna yellowish, washed with black. *Legs*: light brown, black markings as in male imago; claws yellowish, apex orange-brown. *Abdomen*: terga bright yellow-orange, black markings as in male imago but more marked; sterna yellowish-white in first segments turning to yellow-orangish in last ones, all washed with black. Gills whitish, trachea and fimbriae dark gray. Caudal filaments yellow-orange, paler toward apex.

Material: Holotype, male imago: COSTA RICA, Guanacaste, Arroyo #1; Estacion Pitilla, Sendero La Laguna. 12/VI/1989, C. de La Rosa Col (INBio). Paratypes: 1 male imago, same data as holotype (FAMU), 2 nymphs, same data as holotype, except date 16/V/91, R. W. Flowers col. (INBio). The association of the adults and nymphs was made by the abdominal color pattern, from material collected at the type locality.

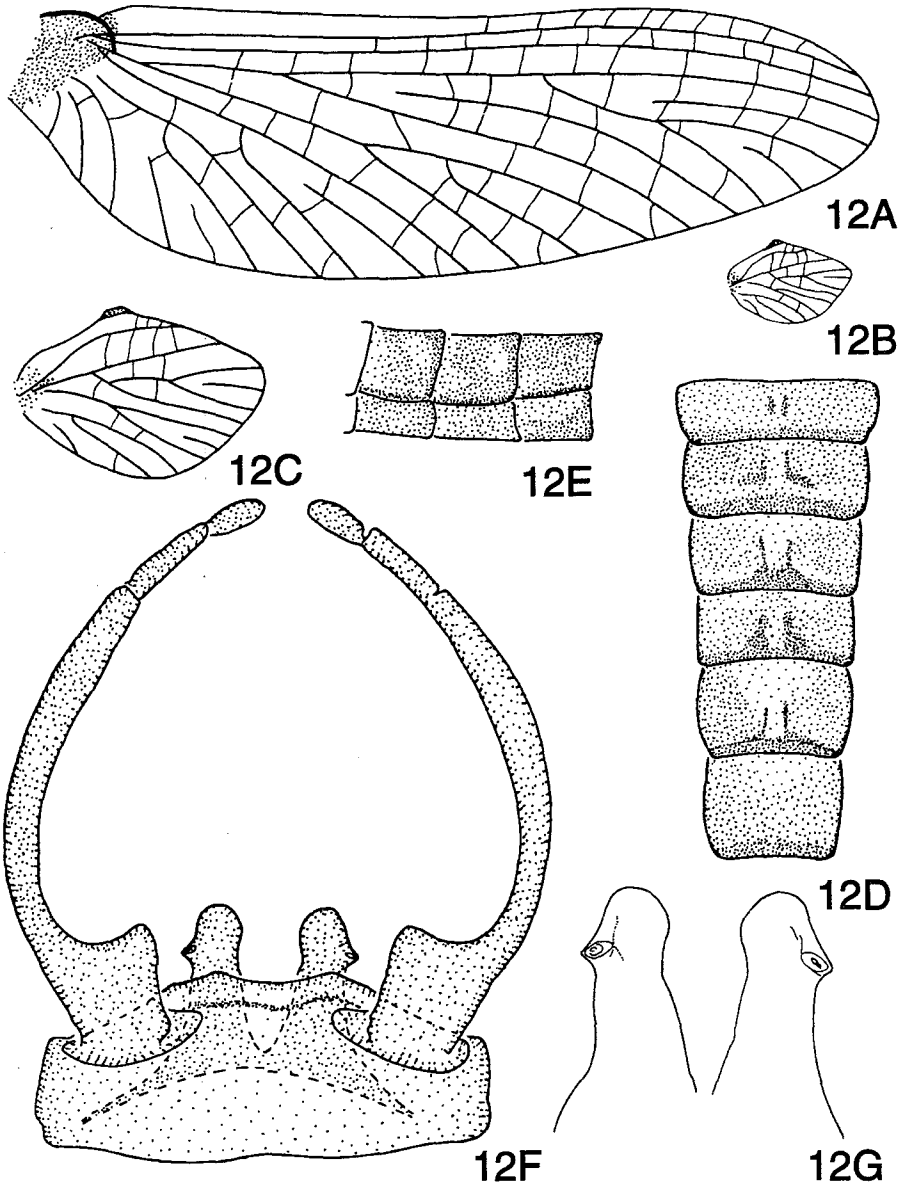

Fig. 12. *Ulmeritoides guanacaste*. Male imago. A, forewing; B, hind wing; C, hind wing enlarged; D, abdominal terga II-VII; E, abdominal segments V-VII, lateral view; F, genitalia (ventral view); G, penis lobes (ventral view, enlarged).

Etymology: Guanacaste: from the type locality, Parque Nacional Guanacaste, Costa Rica.

Variation: The male paratype is darker than the holotype, mainly in the abdominal and genital coloration. The younger nymph is light-brown.

Discussion: *Ulmeritoides guanacaste* can be separated from the other species of the genus by the following combination of characters. In the imagos: 1) forewings (Fig. 12A) hyaline, with veins C, Sc and R1 blackish at stigmatic area; 2) abdominal color pattern as in Figure 12D, E; 3) no cross veins basal to bulla in forewings (Fig. 12A); 4) penis as in Figure 12F, G. In the nymph: 1) Medial denticle on anteromedian emargination of labrum subequal in size to other denticles; 2) tibiae I almost completely tinged with black; 3) dorsum of femora II–III with few short, blunt spines; 4) femora II without median black markings.

Biology: Nymphs were found at the type locality living in leaf packs that had accumulated under a fallen log. The water current was very slow and at the date of collection (May) the water level in the stream was very low.

PHYLOGENY OF THE *ULMERITUS-ULMERITOIDES* GROUP

When Traver (1959) established the three subgenera of *Ulmeritus*, the relationships among the species within the subgenera were unknown, and only the nymph of *Ulmeritus carbonelli* was described. When analyzing the phylogenetic relationships of the *Hermanella* complex (Flowers and Domínguez, 1991), including a reared nymph of a new species of *Ulmeritoides*, it became clear that *Ulmeritus* and *Ulmeritoides* each had enough apomorphies as justify placement in different genera (Domínguez, 1991). *Ulmeritus (Pseudulmeritus) flavopedes* (Spieth) was clearly more closely related to species of *Ulmeritoides* than to *Ulmeritus* and for this reason *U. flavopedes* was transferred to *Ulmeritoides*.

But the relationships between the monobasic *Pseudulmeritus* and the other components of the group remained unknown (Domínguez, 1991). As several new species are described herein, it was necessary to establish their phylogenetic relationships in order to determine the status of *Pseudulmeritus*. When the first draft of this manuscript was completed, only adult characters were used, since nymphs of only *Ulmeritus carbonelli* and *Ulmeritoides misionensis* n. sp. were known.

Traditionally, most of the specific characters in mayflies referred to coloration and genital structures; these characters are difficult to polarize and even to homologize. Because the *Ulmeritus-Ulmeritoides* complex is rather homogeneous, I tried to select characters on which I could establish a transformation series to study the phylogenetic relationships.

Twelve adult characters (characters 1–12, Appendix I) were used and the polarities determined using two outgroups: *Atopophlebia*, the sister group of this complex, and *Meridialaris* which is one of the components of the sister group of *Atopophlebia* + *Ulmeritus/Ulmeritoides* (Flowers and Domínguez, 1991) as outgroups. Binary characters were coded as 0 (plesiomorphic) and 1 (apomorphic). Multistate characters were assigned different numbers indicating different apomorphies and treated as additive. Character 6 (Appendix I) is polymorphic in *Meridialaris* and was coded as “missing.” In order to avoid the problems discussed by Nixon and Davis (1991), treating polymorphic characters as “missing entries,” the behaviour of this character

was studied using alternative codings without any change in the results. Only characters separable into discrete states were used. Polarities were determined by out-group comparison (Watrous and Wheeler, 1981) and following previous studies of Flowers and Domínguez (1991) and Pescador and Peters (1978).

The option used with the Hennig86 (Farris, 1988) program was *ie**, the option guaranteed to find all shortest trees; only one tree was found, with a length of 29, a Consistency Index (CI) of 72 and a Retention Index (RI) (Farris, 1989) of 80.

After this analysis was completed, the nymphs of *U. tifferrae* and *U. guanacaste* were made available to me, by Dr. R. W. Flowers. Using nymphs of *Ulmeritus carbonelli* and *U. balteatus* (recently obtained) and *Ulmeritoides misionensis*, *U. tifferrae* and *U. guanacaste*, I repeated the analysis, this time using characters of both adult and nymphal stages to test the original results. 14 nymphal characters were coded (characters 13–26, Appendix I), and added to the original matrix. (The nymphal characters are separated from adult characters by an empty column in the matrix (Appendix II)). Characters 16 and 24 are treated as non-additive.

Using the same program options, the only tree obtained (length = 50; CI = 82; RI = 85) is identical in branching pattern and adult character distribution to the one based only on adults. This tree was printed with Clados (Nixon, 1992) (Fig. 13).

The analysis indicates that the *Ulmeritus-Ulmeritoides* group is monophyletic, their synapomorphies being: vein ICu2 of forewings attached to Icu1 and CuP (character 2), presence of basal swelling on segment I of forceps (character 10), basal or medial position of dorsal row of setae on labrum (character 14), dorsal row of setae on labrum entire and sinusoidal or divided (character 15), row of setae at base of outer incisor present (character 20), dorsal row of spines present on segments II and III of labial palpi (character 21), presence of lines of pectinate setae on dorsum of tibiae III (character 24) (Fig. 3A) and posterolateral projections on abdominal segments VIII-IX wide and with spines on margins (character 26). There are two major monophyletic groups, one formed by the three species of *Ulmeritus* (*U. carbonelli*, *U. balteatus* and *U. saopaulensis*) and the other by the species of *Ulmeritoides*. Within *Ulmeritoides*, *U. uruguayensis* + *U. spinulipenis* + *U. misionensis* form a monophyletic group, but it is not possible to establish the relationships among them. Their synapomorphies are: the apex of penis lobes rather straight (character 12) and denticles on anteromedian emargination present, with the median one larger (character 13(2)). With *U. flavopedes* they share characters 10(3): inner corner of basal swelling acute, which is homoplastic with *U. fidalgoi*, and as a reversal the absence of ventral projections on penis lobes (character 11). Its sister group is ((*U. guanacaste* + *U. tifferrae*) + *U. fidalgoi*). Synapomorphies shared by *U. guanacaste* + *U. tifferrae* are: cross veins in forewings less than 100 (character 3) and as a reversal vein ICu2 attached to ICu1 (character 2); *U. fidalgoi* share with them the synapomorphy of ventral subapical projections of penis very short (character 11(4)). These two sister groups are linked by the following synapomorphies: in forewings veins C, Sc and R1 darker than the rest (character 6(1)), which reverses in *U. tifferrae* to (6); Vein Sc of hind wings less than .8 length of wing (character 8); basal swelling of forceps not rounded (character 10(2)); tusk on inner apical margin of maxillae small to medium size (character 16(1)); spines on margin of glossae few and big (character 23); and homoplastic with *Atopophlebia* are: cross veins less than 20 in

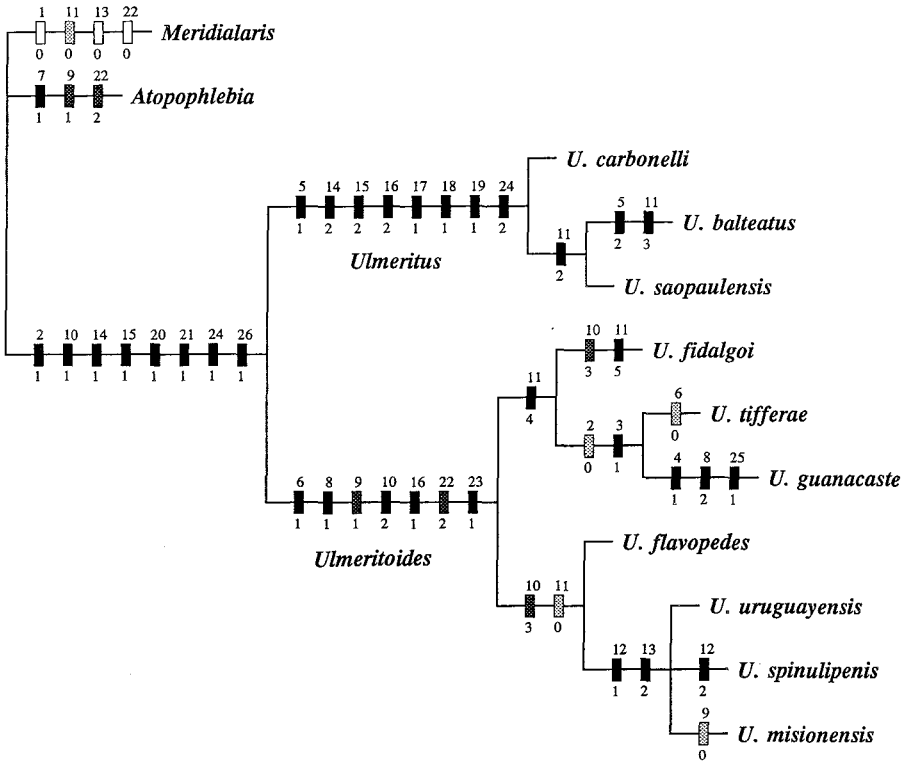

Fig. 13. Cladogram of the *Ulmeritus-Ulmeritoides* group. Black boxes = apomorphies; dark gray boxes = parallelisms; light gray boxes = reversals; empty boxes = plesiomorphies.

hind wings (character 9) and medial row of long setae on dorsum of paraglossae (22(2)).

The three species of *Ulmeritus* form a monophyletic group supported by the following synapomorphies: spots around cross veins (character 5); basal position of dorsal row of setae on labrum (character 14(2)); dorsal row of setae on labrum divided (character 15(2)); tusk on inner apical margin of maxillae big (character 16(2)); palpifer of maxillary palpi enlarged (character 17); ratio segment II/segment III of maxillary palpi more than 0.9 (character 18); the outer margin of maxillae strongly curved (character 19) and line of pectinate setae on dorsum of tibiae III bifurcated at 1/2 length (character 24(2)) (Fig. 3B). *U. balteatus* and *U. saopaulensis* clade is supported by the synapomorphy: digitiform ventral projection of penis medium to short (character 11(2)).

Some characters, such as abdominal color pattern, did give some phylogenetic information. For example *U. uruguayensis*, *U. spinulipenis* and *U. misionensis* all have on the abdominal terga the same pattern of light rounded spot, surrounded by black (Figs. 6B, 8D), not shared by any other component of the group. This character

was not used because it was not possible to discern discrete states for the other species of the group.

The cladistic analysis supported the synonymy of *Pseudulmeritus* with *Ulmeritoides*, the monophyly of *Ulmeritus* and *Ulmeritoides* and their status as sister groups.

It is important to remember that the nymphs of many species in this analysis, including *U. flavopedes*, are still unknown. As soon as they become available, the distribution of their characters will test the pattern of relationships proposed in this paper.

ACKNOWLEDGMENTS

I want to thank Dr. L. C. de Zolessi (URU), Dr. W. L. Peters and Dr. R. W. Flowers (FAMU), Drs. O. S. Flint, Jr (NMNH) for the loan of material, and the last three persons and Dr. Q. D. Wheeler and Dr. R. Meier (Cornell University) for comments on the manuscript. This manuscript was prepared while the author was supported by the Short-Term Visitor Program from the National Museum of Natural History, Smithsonian Institution and finished while at the Department of Entomology, Cornell University, with an External Fellowship, from the Argentine National Council of Scientific Research (CONICET).

LITERATURE CITED

- Domínguez, E. 1988. *Ecuaphlebia*: a new genus of Atalophlebiinae (Ephemeroptera: Leptophlebiidae) from Ecuador. *Aquat. Ins.* 10(4):227–235.
- Domínguez, E. 1991. The status of the genus *Ulmeritus* (Ephemeroptera: Leptophlebiidae: Atalophlebiinae) and related taxa. Pages 157–168 in: J. Alba-Tercedor and A. Sanchez-Ortega (eds.), *Overview and Strategies of Ephemeroptera and Plecoptera*. Sandhill Crane Press, Gainesville, Florida.
- Domínguez, E. and R. W. Flowers. 1989. A revision of *Hermanella* and related Genera (Ephemeroptera: Leptophlebiidae: Atalophlebiinae) from Subtropical South America. *Ann. Ent. Soc. Am.* 82(5):555–573.
- Farris, J. S. 1988. Hennig86 version 1.5 manual; software and MSDOS program. Port Jefferson Station, New York.
- Farris, J. S. 1989. The retention index and the rescaled consistency index. *Cladistics* 5:417–419.
- Flowers, R. W. 1980. *Atopophlebia fortunensis*, a new genus and species from Panamá (Leptophlebiidae: Ephemeroptera). *Fla Ent.* 63(1):162–165.
- Flowers, R. W. 1987. New species and life stages of *Atopophlebia* (Ephemeroptera: Leptophlebiidae: Atalophlebiinae). *Aquat. Ins.* 9(4):203–209.
- Flowers, R. W. and E. Domínguez. 1991. Preliminary cladistics of the *Hermanella* Complex (Ephemeroptera: Leptophlebiidae: Atalophlebiinae). Pages 49–62 in: J. Alba-Tercedor and A. Sanchez-Ortega (eds.), *Overview and Strategies of Ephemeroptera and Plecoptera*. Sandhill Crane Press, Gainesville, Florida.
- Nixon, K. C. and J. I. Davis. 1991. Polymorphic taxa, missing values and cladistic analysis. *Cladistics* 7:233–241.
- Nixon, K. C. 1992. CLADOS version 1.2 manual; software and MSDOS program.
- Pescador, M. L. and W. L. Peters. 1987. Revision of the Genera *Meridialaris* and *Massartelopsis* (Ephemeroptera: Leptophlebiidae: Atalophlebiinae) from South America. *Trans. Am. Ent. Soc.* 112:147–189.
- Savage, H. M. 1987. Biogeographic classification of the Neotropical Leptophlebiidae (Ephemeroptera) based upon geological centers of ancestral origin and ecology. *Stud. Neotrop. Fauna Environ.* 22:199–222.

- Spieth, H. T. 1943. Taxonomic studies on the Ephemeroptera. III. Some interesting ephemerids from Surinam and other Neotropical localities. *Am. Mus. Novit.* 1244:1-13.
- Thew, T. B. 1960. Taxonomic studies on some Neotropical Leptophlebiid mayflies (Ephemeroptera: Leptophlebiidae). *Pan-Pacif. Ent.* 36:119-132.
- Traver, J. R. 1956. A new genus of Neotropical mayflies. *Proc. Ent. Soc. Wash.* 58(1):1-12.
- Traver, J. R. 1959. Uruguayan mayflies. Family Leptophlebiidae: Part I. *Rev. Soc. Urug. Ent.* 3:1-13.
- Watrous, L. E. and Q. E. Wheeler. 1981. The outgroup comparison method of character analysis. *Syst. Zool.* 30:1-11.

Received 6 April 1995; accepted 19 May 1995.

APPENDIX I. CHARACTERS USED IN CLADISTIC ANALYSIS

ADULTS

FOREWINGS

1. Slanting cross vein above MA fork (< with MA approximately 45°): 0 (absent), 1 (present).
2. Attachment of Vein ICu2: 0 (attached to ICu1), 1 (attached to ICu1 and CuP).
3. Number of cross veins: 0 (more than 110), 1 (less than 100).
4. Cross veins basad to bulla: 0 (present), 1 (absent).
5. Spots around cross veins: 0 (absent), 1 (present, not forming bands), 2 (present, forming bands).
6. Coloration of longitudinal veins posterior to and in relation with C, Sc and R1: (lighter or same color), 0 (same color), 1 (lighter).

HIND WINGS

7. Location of apex of costal projection: 0 (in basal 1/2), 1 (beyond basal 1/2).
8. Length of Sc: 0 (>0.8 of wing length), 1 (<0.8 of wing length).
9. Number of cross veins: 0 (25 or more), 1 (less than 20).

MALE GENITALIA

10. Basal swelling on segment I of forceps: 0 (absent), 1 (inner corner rounded), 2 (quadrangular), 3 (inner corner acute, projecting).
11. Ventral subapical projections on penis lobes: 0 (absent), 1 (long, digitiform), 2 (medium-length, digitiform), 3 (short, digitiform), 4 (very short, shallow prominence), 5 (small, spine-like).
12. Shape of apex of penis lobes: 0 (rounded), 1 (rather straight, inner corner obtuse, margin entire), 2 (as in 1, but margin with spines).

NYMPHS

LABRUM

13. Large denticles on anteromedian emargination: 0 (absent), 1 (present, subequal), 2 (present, median one larger).
14. Dorsal row of setae: 0 (apical), 1 (medial), 2 (basal).
15. Dorsal row of setae: 0 (entire, straight), 1 (entire, sinusoidal), 2 (divided).

MAXILLAE

16. Tusk on inner apical margin: 0 (absent), 1 (present, small to medium size), 2 (present, big).
 17. Palpifer size: 0 (normal), 1 (enlarged).
 18. Ratio of segment III/segment II of palpi: 0 (<0.8), 1 (>0.9).

MANDIBLE

19. Shape of outer margin: 0 (evenly curved), 1 (strongly curved).
 20. Row of setae at base of outer incisor: 0 (no), 1 (yes).

LABIUM

21. Dorsal row of long spines on palpi: 0 (on segment III only), 1 (on segments II and III).
 22. Row of long setae on paraglossae: 0 (absent), 1 (present, apical), 2 (present, medial).
 23. Spines on margin of glossae: 0 (numerous (>10), small), 1 (few (<9))

LEGS

24. Lines of pectinate setae on dorsum of tibia III: 0 (absent), 1 (almost two lines), 2 (one main line, bifurcated at 1/2 length).
 25. Spines on dorsum of femora II-III: 0 (numerous), 1 (few).

ABDOMEN

26. Posterolateral projections on abdominal segments VIII-IX: 0 (narrow, with lateral setae), 1 (wide, with lateral spines).

APPENDIX II

Data matrix for the taxa used in this study. Description of character states given in Appendix I. Unknown conditions indicated by "?," polymorphic by "-." Outgroups indicated by *.

Taxon	Character state
* <i>Meridialaris</i>	00000-00000? 00000000000000
* <i>Atopophlebia</i>	100000101010 10000000020000
<i>Ulmeritus balteatus</i>	110020000130 12221111110201
<i>Ulmeritus carbonelli</i>	110010000110 12221111110201
<i>Ulmeritus saopaulensis</i>	110010000120 ????????????????
<i>Ulmeritoides flavopedes</i>	110001011300 ????????????????
<i>Ulmeritoides uruguayensis</i>	110001011301 ????????????????
<i>Ulmeritoides spinulipenis</i>	110001011302 ????????????????
<i>Ulmeritoides fidalgoi</i>	110001011350 ????????????????
<i>Ulmeritoides misionensis</i>	110001010301 21110001121101
<i>Ulmeritoides tifferae</i>	101000011240 11110001121101
<i>Ulmeritoides guanacaste</i>	101101021240 11110001121111