

# Origin and Evolution of Insect Wings and Their Relation to Metamorphosis, as Documented by the Fossil Record

JARMILA KUKALOVA-PECK  
Department of Geology, Carleton University, Ottawa, Ontario K1S 5B6 Canada

## TABLE OF CONTENTS

Abstract .....	53
Introduction .....	55
I. Origin and evolution of wing structures .....	57
Origin of wings and flight .....	57
Principle of recapitulation .....	57
The paranotal theory .....	59
Fossil and comparative-morphological evidence .....	60
Summary of evidence against paranotal theory .....	62
Pretracheation theory of Comstock-Needham .....	64
Spiracular flap theory .....	66
Stylus theory .....	67
Fin theory .....	69
Gill-cover theory .....	70
Synthesis of ideas on wing evolution .....	71
Introduction to wing venation and corrugation .....	73
Origin of wing corrugation .....	76
Flight efficiency .....	78
II. Origin and development of the alar circulatory system .....	79
Circulatory system in modern and primitive wings of juveniles .....	79
Evolutionary changes in blood flow .....	80
III. Origin of wing articulation .....	81
Interpretation of pteralia in primitive Palaeodictyoptera .....	81
IV. Wings and metamorphosis .....	84
Primitive position of wings in nymphs .....	84
Primitive position of wings in adults .....	85
Onset of metamorphosis .....	87
V. Principles of irreversibility and irrevocability of evolution .....	90
VI. Wings and taxonomy .....	91
Differential diagnosis of Paleoptera and Neoptera .....	91
Monophyly and parallel development in Pterygota .....	92

**ABSTRACT** In contemporary entomology the morphological characters of insects are not always treated according to their phylogenetic rank. Fossil evidence often gives clues for different interpretations. All primitive Paleozoic pterygote nymphs are now known to have had articulated, freely movable wings reinforced by tubular veins. This suggests that the wings of early Pterygota were engaged in flapping movements, that the immobilized, fixed, veinless wing pads of Recent nymphs have resulted from a later adaptation affecting only juveniles, and that the *paranotal theory of wing origin is not valid*. The wings of Paleozoic nymphs

were curved backwards in Paleoptera and were flexed backwards at will in Neoptera, in both to reduce resistance during forward movement. Therefore, the fixed oblique-backwards *position of wing pads in all modern nymphs is secondary and is not homologous in Paleoptera and Neoptera*. Primitive Paleozoic nymphs had articulated and movable prothoracic wings which became in some modern insects transformed into prothoracic lobes and shields. *The nine pairs of abdominal gill-plates of Paleozoic mayfly nymphs have a venation pattern, position, and development comparable to that in thoracic wings, to which they are serially homologous*. Vestigial equivalents of wings and legs were present in the abdomen of all primitive Paleoptera and primitive Neoptera. The ontogenetic development of Paleozoic nymphs was confluent, with many nymphal and subimaginal instars, and the metamorphic instar was missing. *The metamorphic instar originated by the merging together of several instars of old nymphs; it occurred in most orders only after the Paleozoic, separately and in parallel in all modern major lineages* (at least twice in Paleoptera, in Ephemeroptera and Odonata; separately in hemipteroid, blattoid, orthopteroid, and plecopteroid lineages of exopterygota Neoptera; and once only in Endopterygota). Endopterygota evolved from ametabolous, not from hemimetabolous, exopterygota Neoptera.

*The full primitive wing venation consists of six symmetrical pairs of veins; in each pair, the first branch is always convex and the second always concave; therefore costa, subcosta, radius, media, cubitus, and anal are all primitively composed of two separate branches*. Each pair arises from a single veinal base formed from a sclerotized blood sinus. In the most primitive wings the circulatory system was as follows: the costa did not encircle the wing, the axillary cord was missing, and the blood pulsed in and out of each of the six primary, convex-concave vein pair systems through the six basal blood sinuses. This type of circulation is found as an archaic feature in modern mayflies. Wing corrugation first appeared in pre-flight wings, and hence is considered primitive for early (paleopterous) Pterygota. Somewhat leveled corrugation of the central wing veins is primitive for Neoptera. Leveled corrugation in some modern Ephemeroptera, as well as accentuated corrugation in higher Neoptera, are both derived characters. The wing tracheation of Recent Ephemeroptera is not fully homologous to that of other insects and represents a more primitive, segmental stage of tracheal system.

Morphology of an ancient articular region in Palaeodictyoptera shows that *the primitive pterygote wing hinge in its simplest form was straight and composed of two separate but adjoining morphological units: the tergal, formed by the tegula and axillaries; and the alar, formed by six sclerotized blood sinuses, the basivenales*. The tergal sclerites were derived from the tergum as follows: the lateral part of the tergum became incised into five lobes; the prealare, suralare, median lobe, postmedian lobe and posterior notal wing process. From the tips of these lobes, five slanted tergal sclerites separated along the deep paranotal sulcus: the tegula, first axillary, second axillary, median sclerite, and third axillary. Primitively, all pteralia were arranged in two parallel series on both sides of the hinge. *In Paleoptera, the series stayed more or less straight; in Neoptera, the series became V-shaped*. Pteralia in Paleoptera and Neoptera have been homologized on the basis of the fossil record.

A differential diagnosis between Paleoptera and Neoptera is given. Fossil evidence indicates that *the major steps in evolution, which led to the origin first of Pterygota, then of Neoptera and Endopterygota, were triggered by the origin and the diversification of flight apparatus. It is believed here that all above mentioned major events in pterygote evolution occurred first in the immature stages*.

## INTRODUCTION

Recently, it was written: "It is obvious, of course, that the natural phylogeny of insects is to be found in the fossil record. However, while the fossil history of the various insect orders is becoming fairly well known in a gross sense . . . , to date, paleontology has not given us any of the phylogenetic proof that we require. We cannot resolve our differences by reference to the fossil record" (Scudder, '73). These words of regret over the seemingly unsatisfactory state of knowledge of the fossil record showed that many entomologists view the benefits from paleoentomology to be mainly if not only in the delivery of missing links, i.e., early representatives of evolutionary lineages and unknown ancestors. Believing in a broad phylogenetic approach to entomological problems, I searched for areas where fossil evidence is *now available* and where the fossil record can shed light upon the many sub-disciplines of entomology. It is necessary at the start to discuss some background operational philosophy concerning insect evolution and morphology, because these viewpoints are closely interwoven with the development of the theses of this paper.

The correct application of the phylogenetic approach to the natural system of classification (Hennig, '66) requires that the taxa should follow, step by step and in correct sequence, the actual events of diversification which took place in evolutionary history. Thus, in general, fossil insects occurring in the Paleozoic contribute data on the highest taxa, such as supraordinal and ordinal, and their diagnostic characteristics; Mesozoic fossils provide information on family and superfamily levels; Tertiary insects help to solve problems mostly at the generic level; and Quaternary fossil and subfossil insects are useful in the study of Recent species, including speciation generated by climatic change and change in geographic distribution.

The recognition of the proper categories of resemblance between morphological characters in relation to their phylogenetic sequence is generally viewed as a major problem of modern systematics. In order to "categorize" the characters it is necessary to recognize them as "primitive" or as "derived," at all respective subsequent systematic levels. Thus, an insect that is primitive within its ordinal level might be highly derived within its specific level, or vice versa, throughout the sys-

tematic ladder (the highly specialized "bifocal" eyes and fore legs of a mayfly male do not effect or alter the fact that Ephemeroptera are the most primitive pterygote order, etc.). Strictly speaking, the character state present in the ancestor is primitive while any change from this condition is derived. However, in practice, deciding which character in a given group of living organisms is primitive and which one derived is often very difficult. For instance, the extant representatives of an ancestral lineage might themselves have acquired newly derived characters, long after it gave rise to the descendant lineage. These might mistakenly be considered as primitive and the understanding of the respective descendant group (at *any* systematic level) might be seriously impaired. It should be therefore always kept in mind that, no matter how many primitive characters are present in a respective organism, there is no basis for the anticipation that *all* should be primitive and none derived.

The correct categorization of characters is often complicated by two related evolutionary phenomena: convergence and parallel evolution. Parallelism includes similarities in two or more genetic lines which have been mainly channeled by a common ancestry, while convergent similarities have been caused principally by environmental selective pressures in less related groups. Of these two, convergence is better understood while parallel evolution, though extremely widespread in insects, has been given relatively little attention. From parallel evolution stems, for instance, the well known phenomenon that an insect appears to be allied with certain relatives when one character is used, but with others when a different character is considered. Again, this phenomenon occurs at all systematic levels. Inevitably, parallelism causes more errors in morphological interpretations than any other evolutionary factor. But, the fossil record, by registering the characters before or in the process of change, has the potential to identify cases of parallelism and convergence, as well as the respective categories of characters.

Many examples are here given of presumably correct observations made by Recent morphologists. However, it is not the goal of this paper to base *any* conclusions entirely on the results of modern morphology. Information from comparative morphological studies may be biased by anticipation, the incidence

of which is much more probable in the higher taxonomic levels, which are the concern of this paper, than in lower categories. The higher taxa in the Pterygota reflect phylogenetic events which mostly took place some 300 to 400 million years ago and an impressive adaptation of the basic characters changed many of them almost beyond recognition. Therefore, the interpretations of Recent morphologists are here confronted with data present in the fossil record, as is currently done with vertebrates and many invertebrate groups other than insects.

From the above-mentioned considerations it should be clear that: (1) living forms provide only *indirect* evidence for establishing the natural system and for interpreting morphology, (2) although it is tempting to arrange extant characters in a series of primitive and advanced stages, series of this sort may contain numerous errors, (3) comparative studies of the morphological features of living insects, while they can provide a great amount of information, have always to be considered and treated as *indirect evidence* for both taxonomic and evolutionary morphological purposes, (4) living organisms are almost always mosaics of primitive and derived characters which resulted from adaptation to their particular ecology. Intricate adaptive processes frequently obliterate the origin of these features, but the fossil record can present an immediate testimony to a particular phylogenetic state.

In the present paper, I seek to show the complementary nature of modern comparative insect morphology and paleoentomology, in an attempt to harmonize the observations in both disciplines, and to draw some possible conclusions.

To help the reader understand the thesis to be developed, some phylogenetic concepts are mentioned, which will be discussed and documented later, and several terms are defined for clarity.

*Phylogeny.* Pterygota are considered to be descendent from the ancient Apterygota, ancestral to both Archaeognatha (including fossil Monura) and Thysanura. The alar articulation in early flightless Pterygota, as believed here, did not allow flexing of the incipient wings back over the body at rest. This type of articulation is known as *paleopterous* (flexing of the wings should not be confused with the ability of some Recent Odonata and Ephemeroptera to *fold* their wings simply

upward over their back). The first flying insects belonged to the Paleoptera which had a paleopterous alar articulation and a deep, regular wing corrugation; in the Paleozoic they included the following orders: Palaeodictyoptera, Megasecoptera, Protodonata, Diaphanopteroidea, Ephemeroptera and Odonata; only the last two are extant. Neoptera presumably became derived from early Paleoptera by adapting one sclerite (the third axillary) which acquired a pivoting position and enabled the wings to be flexed backwards at will. This type of articulation is called *neopterous*. The central alar veins (M, Rs) of Neoptera are more or less flat and therefore the wing corrugation is not as regular as in Paleoptera. Fossil wings can be classified according to this last feature even if fragmented. Paleozoic Neoptera contained the orders: Protorthoptera (a large composite order including hemipteroid, blattoid, orthopteroid and plecopteroid types of primitive insects), Blattodea, Protelytroptera, Orthoptera, Caloneuroidea, Plecoptera, Miomoptera, Hemiptera, Psocoptera, Neuroptera, Megaloptera, Glosselytroidea, Coleoptera, Mecoptera, and Trichoptera. Endopterygota supposedly evolved from early exopterygote Neoptera.

*Wings.* Pro-wings, or pre-flight wings, are the incipient but functional "wings" of early flightless pterygotes which were present on *all thoracic and abdominal segments*; winglets are small (thoracic and abdominal) wings; prothoracic winglets were primitively functional, but were later immobilized, and became transformed homologues of pterothoracic and abdominal wings; gill-plates or gill-covers are abdominal wings of some aquatic nymphs; veins are tubular, cuticularized and sclerotized thickenings which in the Paleozoic occurred in the wings of both nymphs and adults, but in the Recent are present *only in the adults*; corrugation or fluting is the fan-like folding of the wing so that the convex veins (+) form ribs rising above, and concave veins (-) form grooves receding under, the wing plane; a given vein is always primitively either convex or concave but it can become secondarily neutral (flat) by losing its corrugation; mechanization of wing venation is a shifting of the costa, subcosta, and radius anteriorly and parallelly to support the anterior margin as is essential in flying wings.

*Metamorphosis.* Most physiologists agree that metamorphosis is only that part of post-embryonic development which takes place in

the absence of a morphogenetically active concentration of juvenile hormone, i.e., the last larval instar of exopterygote Neoptera and both the last two larval instars (prepupa and pupa) of Endopterygota. Ametabolous development is a confluent ontogenetic development in which moulting does not cease with the acquisition of sexual maturity and the metamorphic instar is missing; it occurs in modern Apterygota and was probably present in all primitive (mostly Paleozoic) Pterygota; incremental (confluent, sequential) ontogenetic series of developmental stages are documented for the Paleozoic orders, in which the increase in size between the first instar and the adult was completely confluent with numerous subimaginal instars, so that the metamorphic instar was not "needed." The multiple origin of metamorphosis is the most probable explanation for the fact that some living *metabolous* insect orders are documented to have *ametabolous* Paleozoic ancestors with confluent ontogenetic development. "Nymph" is used as a convenient morphological term for the juveniles of Paleoptera and Neoptera-Exopterygota without implying a hypothesis on metamorphosis.

#### I. Origin and evolution of wing structures

##### *Origin of wings and flight*

Few events in the Animal Kingdom have been the subject of as many hypotheses as the origin of insect wings (for summaries, see Alexander and Brown, '63; Sharov, '66; Wigglesworth, '76; Wootton, '76). The aim of this section is not to propose an additional hypothesis, attractive as this may be, but to review the fossil evidence that substantially limits the variety of plausible explanations of the origin of insect wings.

The fundamental questions are the following: 1. Are the wings "new" (pterygote) structures or are they adapted "old" (arthropod) structures? 2. If they are new structures, what was their origin and primary function? 3. If they are old structures, with what are (or were) they homologous in other arthropods? 4. Are there abdominal appendages that are serially homologous with the thoracic wings? 5. What were the agents that promoted the preadaptation of the thoracic pro-wings for flight, with respect to size, mechanized venation, membranization, articulation, and musculature, before they were yet capable of flying? Analysis of the fossil evidence now at hand provides a clearer insight into some of

these questions and shows that some of the previous hypotheses can be eliminated.

##### *Principle of recapitulation*

The correct interpretation of the principle of recapitulation (partial recapitulation of phylogeny in ontogeny, following De Beer, '58; Novák, '66; and many others) is particularly important for a theory of the origin and early evolution of the wing. Formerly the more mature nymphs of hemimetabolous insects were used for this purpose, but a comparison of these nymphs with primitive Paleozoic nymphs has revealed that they have become too specialized, through adaptation to their particular needs, to reflect their phylogeny (see section IV, *Primitive position of wings*). The recapitulation model of alar origin which was based upon the morphology of older nymphs has led to confusion. For instance, the nymphal wing pads of Recent Ephemeroptera, which are fused with the tergum and are fixed in a lateroposterior position (fig. 29), were considered to be in the primitive position. Therefore Lemche ('40, '42; and followers) concluded that Ephemeroptera are closely related to Neoptera, that the Paleoptera are not monophyletic, that the Odonata are not monophyletic with other Pterygota and, as another variant, that Ephemeroptera are intermediate between Paleoptera and Neoptera. This is a misreading of secondarily derived features for a recapitulation of phylogenetic characters, and is contrary to the fossil evidence that is now available (fig. 30).

A more suitable recapitulation model, which is in agreement with the fossil evidence of Paleozoic nymphs, was found in the ontogenetic development of *younger nymphs* of some Recent Paleoptera and Neoptera (in Odonata and Ephemeroptera by Bocharova-Messner, '59, '65; in Hemiptera, Orthoptera and Blattodea by Tower, '03). In the specimens examined, the wings primitively started as epidermal thickenings, then evaginated as wing-sacks or folds, and migrated during several moults towards the tergum, with which they eventually fused; at that point they came to acquire their appearance as older nymphs (fig. 36, I-VIII). It was found that the wings started as separate structures, independent from the tergum in younger nymphs, but became fused with the tergum and immobilized in older nymphs; consequently they cannot be paranota.

The sequence of stages in the development

of the wing of living Libellulidae and Aeshnidae is, according to Bocharova-Messner ('59), as follows: In the first nymphal instar, the wing starts as an epidermal thickening whose location is marked externally only by the presence of two prominent setae (fig. 36, I). The thickening is located just above the spiracle, lateral to, and well apart from the tergum. In the second instar, a wing thickening with two setae becomes slightly outlined. It increases in size and, with each successive instar, moves closer to the tergum. Sometime during its upward migration, it evaginates to form the actual wing bud. In about the sixth instar in Libellulidae and the fifth instar in Aeshnidae the wing bud finally reaches the tergum and adjoins it laterally. Within the next instars it enlarges and, at last, changes into a flattened wing pad. The wing pad migrates upward on the segment and its apex eventually becomes directed backwards (fig. 36, VIII). Only in this stage does the nymphal wing pad start to resemble the "paranotum" and gain the postero-laterally oriented "neopterous" appearance. In the ninth and tenth instar, the wing pad twists over on the back (the same position is acquired in the antepenultimate moult of Orthoptera, by evolutionary convergence). Further changes, up to that in the final nymphal instars, are mostly only quantitative.

According to Bocharova-Messner ('65) the nymphal wing pads of Ephemeroptera undergo a similar development, but because of the compression of the number of instars, recapitulation is less distinct at the beginning of the ontogenetic series. The wing sack is omitted and the wing evaginates as a narrow lateral fold close and parallel to the tergum. Later, it fuses with the tergum and combines with the narrow posterior tergal fold to encircle the tergum laterally and posteriorly. Starting in about the sixth instar, the fold elongates successively at the posterolateral angle. Gradually it gains more and more resemblance to the wing pads of neopterous nymphs, especially to Plecoptera. In this way the mayfly nymphs not only become equipped with "paranota," but also become "related" to Neoptera, on the grounds of the convergent external resemblance of the older instars of both groups. However, Neoptera were derived from paleopterous stock, but *not from Ephemeroptera* (see sections IV, VI).

Observations on the development of wings in early instars of Hemiptera, Blattodea, Orthoptera, Coleoptera and Lepidoptera were

made by Tower ('03). He found that the epidermal alar thickening (wing disc) invariably appears just above the spiracle in all pterygotes. In *Anasa tristis* (Hemiptera), the wing-discs arise in the embryos and are evaginated at the time of the first moult. In *Periplaneta* (Blattodea), the epidermal wing-disc migrates dorsally and posteriorly, and when it evaginates, it imitates the postero-lateral paranotal lobe without being a homologous structure. In *Microcentrum latifolium* (Orthoptera) the wing disc evaginates in the embryo *beneath the cuticle*, but does not become external until after the first nymphal moult.

Bocharova-Messner ('68) studied the ontogenetic development of the flight apparatus (the skeleton, the musculature, and the wing-buds) in *Blatta*, *Blattella*, *Gryllus*, *Oecanthus*, *Acheta*, *Perla*, and *Locusta*. She confirmed Tower's observations and found that the data on wing development accumulated by her in juvenile Paleoptera ('59, '65) are also valid for the Neoptera. She concluded that the developing wings in the nymphs became secondarily adapted to a new purpose: to provide additional protection for the lateral parts of their bodies. The beginning of the wing-discs and their migration dorsally and posteriorly was found to be especially well expressed in the roaches. Ironically, this group has for a long time been considered to be the bastion of the paranotal theory (Lemche, '42; and others).

Wing development in the crickets was similar to that in roaches, but the wing-fold evaginated first in the lateral position and only then migrated to fuse with the tergum. In grasshoppers, due to embryonization of earlier instars, wing development started in the embryo and the wing fold was already present in the first instar, as previously observed by Tower ('03).

In all, Tower and Bocharova-Messner reached the same results: that the wings are in no sense a "dorsal backward prolongation of the tergum," but *free lateral structures* which, for the mechanical convenience of the immature insects, are shifted in later moults to another position and fused with the tergum (or tergal paranota if they are present). Tower ('03) was perhaps the first author to be convinced that the ontogenetic development of wing structures in Paleoptera and exopterygote Neoptera was fully comparable with that of the Endopterygota; this concept is presently accepted by many students of entomology.

The fossil evidence, which will be discussed in more detail in the next section; shows that all Paleozoic nymphs of Paleoptera and most primitive Neoptera have articulated and functional wings throughout their whole ontogenetic development. This fact strongly supports Tower's conclusion that the wings are free lateral structures.

#### *The paranotal theory*

In the currently quite popular paranotal theory, also known under the spirited name of the "flying squirrel theory" (Müller, 1873-1875; Crampton, '16) the wings are derived from rigid, doubled, lobe-like expansions of thoracic terga, the paranotal lobes. Recent support for the paranotal theory has been given by Sharov ('66), Hamilton ('71-'72), Wootton ('76), and Rasnitsin ('76).

Paranota are lateral expansions of the terga which, in numerous arthropods, serve as protection for the sides of the body and limbs. They are described in trilobites, crustaceans, Acarina, and myriapods. In insects, they are typically developed on the terga of Apterygota. Paranota are primitive, may possess venation, and may even develop a simple hinge along a desclerotized line so that they may become movable up and down to some extent (as the leg-protecting devices of galumnid mites). Paranota of silverfish strongly resemble, in general morphology and tracheation pattern, those of immobilized wing pads in older pterygote nymphs. The recapitulation principle, as well as these data of comparative morphology, seemingly favor homology between pterygote wings and thoracic paranota of the Apterygota, if phylogenetic considerations are omitted.

In the classical view of the paranotal theory, the wings originated as follows: initially the protective thoracic paranota became enlarged and acted first as parachutes in delaying descent; next as gliding surfaces; then as steering vanes; and ultimately as flapping aerofoils (Wootton, '76). This concept seemingly finds support in the ability of some insects to glide and steer on wings oriented at an angle to the body, and in the morphology of some oribatid mites. Woodring ('62), after a detailed study of the hinged, movable, tracheated and veined pteromorphs (paranota) of the oribatid mite *Galumna eliminatus*, saw a parallel between the pteromorphs and insect "paranota," which he believed to be precursors of wings. He anticipated controlled gliding as a preadaptation to flying. All these data seem

to uphold the paranotal theory. However, the hinges of pteromorphs in oribatid mites are simple lines of weakness and they show only that *any* protruding lobes might become movable through the attachment of near-by musculature. This movability of integumental evaginations also occurs in structures like spurs. In mites, the pteromorphs have nothing to do with flight, but serve as protective devices (if pulled in, the already smooth body becomes completely globular). On the other hand, the controlled gliding in butterflies, dragonflies, locusts and other insects, is accomplished on large wing planes, with *sophisticated articulation* and mostly with the help of special locking mechanisms to hold the wings outstretched. It does not prove the pre-existence of a solid tergal outgrowth, any more than does the gliding of an eagle "prove" the pre-existence of a solid, spinal outgrowth that eventually broke up into joints because of the eagle's frequent gliding (!).

Indeed, flapping flight structures have probably never evolved anywhere in the Animal Kingdom, unless a suitable set of joints, muscles, etc. were previously present and preadapted for more specialized flapping function. However, gliding is often used by animals with flapping abilities as an energy-efficient way of flight (typically by flying fish). We have flapping flight alternating with gliding flight in flying reptiles, birds, bats and insects. Contrary to this, the "gliders," namely squids, lizards, snakes, marsupials, and squirrels, are restricted only to gliding flight, because the *primarily* gliding planes do not need any "flapping" character to be effective. After an existing gliding organ has been perfected, "natural selection would eliminate the individuals less apt at soaring. Hence, once a soarer, always a soarer" (Grant, '45). It is therefore hard to believe that in insects the sophisticated flight apparatus developed from solid lateral extensions of the body. Through the years, many efforts have been devoted to proving that insects could successfully glide on small lateral "paranota." Such an ability cannot be reasonably doubted, as long as the insect body, or a simulation model, or any other body, do not violate certain aerodynamic laws. But this, clearly, does not furnish any evidence for a particular origin of the wings. All conclusions on this matter are oversimplified and mechanistic.

On the other hand, any flapping organ is bound to be very complicated and sophisticated. It is generally believed among paleon-

tologists that a flight organ has to pass through an intensive preadaptation period before it can be used for this function in an aerial environment. For instance, to become preadapted for flapping flight the insect wing had to acquire a sufficiently large and thin plane, supported by stiffened and corrugated venation, an incipient rotating mechanism, and a coordinated set of flight muscles. There is an indication in the fossil evidence that all these characters might have evolved already in the pre-flight wings (see following section on origin of wing corrugation); and there is a convincing fossil record documenting that the wings of pterygotes evolved from freely articulated lateral appendages, as will be described in more detail below.

It should be noted that soaring occasionally occurs in various insect orders. Among Paleoptera, the wings of dragonflies are in an elastic equilibrium (i.e., their placement is effortlessly maintained) when they are in the horizontal position convenient for gliding (Neville, '65). In Neoptera, the outspread placement of wings has to be secured by various cuticular locking mechanisms (Neville and Weis-Fogh, in Neville, '65) acquired by adaptation. Thus the locusts, the fly *Chironomus* and the lacewing *Chrysopa* glide with locked fore wings, while the stag beetle *Lucanus* glides with locked hind wings. Locking mechanisms are diverse and probably widespread. I believe that the ability to use both soaring and flapping flight in Paleoptera is primitive and that early Pterygota, which had their wings in the paleopterous position (fig. 46B), were able to fly with alternating periods of soaring and flapping. However, the evolutionary trend was towards improving the flapping, and soaring was retained as an option which every flying animal possesses to some degree. Effortless gliding was bound to be very important, especially in an early evolutionary period when flight was imperfect and the wing beat slow, because it is energetically the most economical way to gain height and to disperse. In contrast, the locking mechanisms in Neoptera are clearly secondary adaptations for regaining soaring which was lost when the wings had developed the ability to flex backwards. This new adaptation evolved independently in diverse groups to conveniently support either pair of wings.

The paranotal theory was constructed upon three basic points: 1. The "proof" offered by ontogeny was seen in the fact that the wing

pads of all modern nymphs are not articulated to, but are directly continuous with, the tergum; the haemocoel, nerves, and tracheae continue unobstructed from the body cavity into the wing pads, and the latter thus seem to form perfect postero-lateral outgrowths of the tergum (figs. 3, 4). 2. The "proof" of the serial homology was based on the similarity between nymphal wing pads, prothoracic lateral expansions, and abdominal lateral expansions, because they show the same rigid and unobstructed connection with the notum. 3. The "proof" offered by the fossil evidence has been erroneously reported by paleontologists (see below). Lateral lamellae on the palaeodictyopteran abdomen (here interpreted as marginal subcoxae, figs. 22-24) were generally considered as paranota serially homologous to wings. Prothoracic winglets of Paleodictyoptera were viewed as "typical paranota" proven to be primitively continuous with the pronotum and forming its solid lateral outgrowths (see fig. 1 for an opposite view). Since prothoracic winglets carry venation homologous to wings (fig. 14), the paranotal theory was given powerful but false support (Hamilton, '71-'72). Wootton ('76) admitted that they might actually reflect the somewhat movable "steering vanes," which are, according to the paranotal theory, the hypothetical stage between solid paranota and articulated wings.

The ancestral insect "gliders" were reconstructed as carrying on their thorax either three pairs of "paranotal" lobes which looked like prothoracic winglets of Palaeodictyoptera but were considered to be immobile (Zalesky, '53) or which looked like nymphal wing pads of modern roaches and were spread permanently obliquely backwards (Sharov, '66). The "paranota" on the abdomen were anticipated as similar to the thoracic ones but smaller. The timing of gliding and wing origin were then explained by the synchronous occurrence of high trees at the end of the Devonian (Hocking, '57), from which the insects voluntarily jumped or were knocked off by wind.

#### *Fossil and comparative-morphological evidence*

The fossil record confirms none of these "facts" that "support" the paranotal theory. In fact, it provides evidence to the contrary. In the last decade, numerous nymphs of generalized Paleozoic orders have been described and these were found to have articulated and



functional thoracic wings: Ephemeroptera by Kukalova ('68); Megasecoptera by Carpenter and Richardson ('68); Palaeodictyoptera by Sharov ('66, '71a,b), Wootton ('72), and by Kukalova-Peck and Peck ('76); Protorthoptera by Sharov ('57a, '66) and Miomoptera by Sharov ('57b). Independently articulated abdominal wings have been lost in most orders except in some Protorthoptera (fig. 35), (Carpenter, '35), and Ephemeroptera (Kukalova, '68). All these nymphs, some 300 million years before the Recent, had freely articulated wings even in the youngest instars (Kukalova, '68) (figs. 6, 22, 24, 25, 28, 30, 31, 33, 35, 47, 48). Modern juveniles descendent from Paleozoic lineages (fig. 46A: Recent) then can not be morphologically more primitive because of their possession of functional structures that are like "paranota." Clearly, the articulated wings of Paleozoic nymphs are primitive, while the immobilized wing pads fused with the tergum in modern nymphs are derived.

It is concluded that all body segments in Paleozoic nymphs carried wings which were primitively movable. This movable attachment was carried over from the immediately pre-flight Pterygota in which yet undiscovered articulated pro-wing structures were situated along the whole body and were involved in active motion beginning with the young nymphal instars. The immobilizing of the thoracic and the loss of the abdominal wings in the nymphs of some Pterygota was already underway in the Upper Carboniferous (figs. 22, 24) and has proceeded ever since in all major lineages.

If the movability and articulation of Paleozoic nymphal wings is known to paleoentomologists, how is it then possible that Sharov ('66), Wootton ('72, '76) and Rasnitsin ('76) defended the paranotal theory?

Sharov's support for the paranotal theory stemmed from an error in classification. He believed that two isolated, chitinous, veined, telsonal plates (uropods) of a Devonian crustacean, *Eopterum devonicum*, were the wings of an ancient pterygote (Rohdendorf, '72). Hypothetical paranota in the transitional stage of "steering vanes" would probably have looked similar to these plates, if the paranotal theory were valid.

Wootton ('72, '76), and Rasnitsin ('76) studied only the nymphs of Palaeodictyoptera and did not have the opportunity to examine other Paleozoic Paleoptera. Some of these nymphs

were rather peculiar and heavily sclerotized, and the functional efficiency and mobility of their wings were reduced by this specialization (they presumably avoided predators by pressing against the substratum), (figs. 22, 24). I studied fossils of the nymphal wings of Ephemeroptera, Megasecoptera, Palaeodictyoptera, various Protorthoptera, and Blattodea, and closely examined the way in which they are attached to the tergum. The articulation and degree of mobility varies in different groups of both Paleoptera and Neoptera. The most primitive condition, with a clearly independent attachment and the greatest manoeuvrability, is found in the Ephemeroptera (figs. 28, 30) and the Megasecoptera (fig. 31). In Protorthoptera the condition varies from completely independent wings (figs. 35, 47, 48), known also to Sharov ('57a,b, '66), to wing pads fused completely with the thorax. The last, a specialized condition, is characteristic for blattoid Protorthoptera and especially for the Blattodea which were the first to attain the typical morphology of modern nymphs. There is hardly any doubt that the trend to repress the articulation and to immobilize the wing pads started very early in Paleozoic nymphs and has since proceeded in all lines, but at different rates. However, the fossil evidence of primitive movability is convincing, especially in Ephemeroptera: about 100 minute nymphal wings were found in the lower Permian deposits of Oklahoma (F. M. Carpenter, personal communication, and personal observation) which were broken off along the hinge line identically as were the wings of the adults. A similar phenomenon is known also in numerous Paleozoic Megasecoptera. This provides convincing evidence that in the ontogeny of primitive Paleozoic lines of Pterygota even the youngest nymphs could flap their wings.

Both Wootton and Rasnitsin considered the function of the deep groove (previously described by Sharov, '71a,b) along the base of the palaeodictyopteran nymphal wings (figs. 6a-c, 23, 24), and independently concluded that it is a simple line of bending. They compared this structure with the groove along the wing base in some nymphal Neoptera, and presumed them to be homologous. This "homology" was believed to support the paranotal theory.

However, this conclusion is based upon a misinterpretation. The deep groove along the wing base in palaeodictyopteran nymphs is the *paranotal sulcus* (figs. 45A,B: pa), which

is part of the sophisticated articular region of the functional wings. This is typical for the primary pterygote hinge of the paleopterous type, which was straight and composed of serially arranged pteralia (as documented here in section III on *Origin of wing articulation*). The groove, along with the presence of pteralia (figs. 6, 22; Wootton, '72: fig. 3b; Rasnitsin, '76: figs. 1a-c) indicates the presence of an articular region in very young nymphs of Palaeodictyoptera which alone provides a uniquely strong argument *against* the paranotal theory. The shallow grooves along the base of the neopteran wing-pads, on the other hand, are either the mesal limits of the movable wings, or the lines of fusion between the wings and the tergum along the anal area.

The evidence of the fossil record as to the "immobility" of prothoracic lobes is simple: there are no primitively immobile prothoracic lobes which could logically be homologous with wings (figs. 14-21). Instead, they were primitively movable and are now secondarily immobile. Traces of former mobility in prothoracic lobes can be detected in both fossil and Recent insects. Evidence of positively movable prothoracic winglets in some Palaeodictyoptera is presented in fig. 1 (both winglets are separated from the pronotum and superimposed). Also, a certain movability of lobes in some Protorthoptera is not excluded (Carpenter, '50, '66: plates 4, 5). Prothoracic lobes of most adult Protorthoptera are immobile and protective (fig. 16), and occasionally carry sensillae (fig. 17) similar to those of some modern insects. However, in undescribed material in my collection, there are several nymphs of plecopteroid Protorthoptera that might possibly have had movable prothoracic wing pads (fig. 35). Paleozoic adult and nymphal Ephemeroptera from the Lower Permian have membranous prothoracic winglets (figs. 15, 28), with remnants of venation and a crescent shaped vestigial hinge. In undescribed material from Mazon Creek, Illinois (Upper Carboniferous, in the Field Museum, Chicago) I have seen a paleopterous nymph with three pairs of thoracic wings in a rowing position, equal in size and with a mechanized venation pattern. Recent prothoracic winglets in mayfly nymphs were described by Ide ('36) and are known in *Dolania* (Tsui, personal communication). In Paleozoic roaches (figs. 19-21), the crescent shaped articulation of the wing lobe with the prothorax is clearly indicated, while

in Recent forms this hinge-vestige has mostly disappeared. However, in some Recent praying mantises the rudimentary cuticular, crescent-shaped hinged base is quite distinct (fig. 18). Further proof of the serial homology in tracheation is given in the prothoracic wing lobes of mutated *Blattella germanica*, by M. H. Ross ('64). The prothoracic tracheal wing-loop (transverse basal trachea of Whitten, '62) of these nymphs not only bears marked resemblance to that of the mesothoracic wing, but also is connected to the genuine (though temporary) prothoracic spiracle, which occurs for a short time in early instars (otherwise, the prothoracic spiracles in all adult living insects are completely missing).

In any case, whether the prothoracic winglets are preserved in the form approaching that of pre-flight wings as perhaps is the case in Palaeodictyoptera, or whether they had been mechanized for some kind of forward motion (terrestrial or underwater) as in some undescribed fossil material, or whether they had lost mobility and served to protect the head and legs, they are all homologous to wings and primitively were articulated to the prothorax.

Genuine prothoracic winglets should not be confused with true prothoracic paranotal lobes, which exist on the terga of brisletails and silverfish (Apterygota), or with narrow lateral notal extensions that occur in some juvenile and adult pterygotes. Also, prothoracic lateral extensions present in many Hemiptera are not equivalent to wings, because they are well behind the pleural ridge, at the dorsal end of which the wings would be expected to articulate. The wing-derived prothoracic lobes are recognizable on the basis of their pleural suture which is roughly oriented towards the former location of the wing's articular region.

#### *Summary of evidence against the paranotal theory*

The articular attachment of wings in all primitive Paleozoic nymphs leaves no doubt that solid paranota engaged in gliding did not come first in the evolution of flapping insect wings. In fact, the adaptive trend was exactly the opposite: the nymphal wings lost their movability by fusion with the tergum, developed a thickened integument reinforced by cuticular rugosities of various kinds, and thus finally came to be convergent with paranota. The function of these changes was to protect

tender wing tissue (and sometimes the legs) and to streamline the body (compare figs. 29 and 30).

In the past, the comparison between the thoracic wings and the lateral margined abdominal expansions, generally considered to be paranotal lobes, has been the strongest argument in favor of the paranotal theory, and in many discussions has been the decisive observation. However, the interpretation that *all* abdominal lateral expansions in Pterygota are derived from the terga is doubtful, as shown in following text.

According to the fossil evidence, the vestigial abdominal wings and legs were primitively present on all abdominal segments of both nymphal and adult Paleoptera and Neoptera (figs. 46A,B). In Paleoptera, articulated abdominal wings are preserved in the nymphs of mayflies (fig. 25A), and are sometimes noticeable as vestiges in mayfly adults (Birket-Smith, '71: fig. 1A). In Recent juvenile Ephemeroptera all sclerites of each abdominal segment are fused into a ring and are discernible only with difficulty. Their arrangement, nevertheless, is homologous with that of the pterothoracic segments: the tergum, the wing (a gill-plate, articulated between the tergum and the subcoxa), the (margined) subcoxa, the coxa (to which is attached the leg-derived gonostylus), and the sternum (Snodgrass, '35: fig. 150). This interpretation of the abdominal segments is probably valid for all fossil and living Paleoptera. In some Paleozoic adult Diaphanopteroidea (undescribed material from the L. Permian of Czechoslovakia), and some living dragonfly nymphs (Calvert, '11; Corbet, '62; Matsuda, '76: p. 134) vestigial legs are attached to the abdominal coxal region and thus help in its identification. It is believed here that the extended sides of the abdomen (also called lateral lamellae) of all immature and adult Paleoptera, are formed by the *margined subcoxae* and not by the "paranota," as frequently anticipated. This interpretation, formulated first by Börner ('08), has been based upon the *serially homologous position and the adjacent musculature of the abdominal subcoxae in living Ephemeroptera* (fig. 25A). The fossil record gives support to this idea in the morphology of abdominal "paranota" in primitive Palaeodictyoptera and Megasecoptera from the U. Carboniferous (Muséum d'Histoire Naturelle, Paris, '77, personal observation): Paranota are supposed to be lateral

folds of the tergal margin. Hence, they are expected to be primitively continuous with the tergal plate and well sclerotized, besides being doubled. In primitive Paleozoic insects, however, the lateral parts of the abdominal segments are separated by a suture which is often oblique (figs. 22-24: SCX); under glycerin these fossilized "paranota" become transparent and are obviously less sclerotized and pigmented than the neighbouring abdominal terga. Consequently, they can hardly represent solid, doubled tergal lateral outgrowths. More probably, they are pleuron-derived structures, perhaps margined subcoxae.

It should be noted that, within the paleopterous orders, the occurrence of the abdominal wings, legs, and margined "lateral lamellae" (however they are interpreted), excludes the possible origin of wings from these respective lateral lamellae. This conclusion is, of necessity, valid for all Pterygota with the assumption that: 1. the thoracic and the abdominal segments in insects are serially homologous, 2. the paleopterous Pterygota are ancestral to the neopterous Pterygota.

In Paleozoic Neoptera, the abdominal wings have been found so far only in some immature (Carpenter, '35) and adult (Kukalova, '64: fig. 47) plecopteroid Protorthoptera and in additional protorthopterous nymphs from the Lower Permian of Kansas (figs. 25B, 35, 47, and undescribed material). Vestigial abdominal legs are present as diverse styli and cerci in many Neoptera, and most notably form the gill-legs (tracheopods) in dobsonfly and sisyrid larvae. It is therefore very probable that the abdomen of the most primitive Neoptera was very similar to that of Paleoptera and carried both wings and legs on each segment. The wings have usually been lost without a trace. However, in blattoid orders (both extant and extinct) and perhaps also in other orders, there is another possibility to consider: that the abdominal wings might have become fused with the edge of the tergum in the same way as did the nymphal thoracic wings, and persisted there into the adult stage. This alternative possible interpretation is inspired by the fact that the Paleozoic blattoid lineage was the first to acquire a modern nymphal morphology and the first to develop the metamorphic instar. This early evolutionary event might have perhaps heightened the chance that *all* wings along the body undertook the same process of fusion with the edges of their respective terga. If this is true, the marginal

parts of the nymphal prothorax, the pterothorax, and the abdomen in roach-related orders might in reality be serially homologous, as assumed by the paranotal theory. At the same time, they are by no means derived from tergal (paranotal) expansions.

It seems that the notal lateral extensions were primitively either small or absent in ancestral Paleoptera and that they stayed primitively small or absent also in early descendent Neoptera. The features described as abdominal "paranota" or "paratergites" in Hemiptera might be, at least in some cases, interpreted as margined pleura which grew together with the terga. The problem of the pterygote lateral abdominal region needs deep comparative study in all major lineages, including the varied position of the spiracle and of the pleural membrane. However, the primitive small size or absence of notal lateral expansions in earliest pterygotes seems to be essential for the origin of wings, and to be phylogenetically more sound. It is also in agreement with fossil evidence and serial homology in primitive Recent insects.

To summarize the various possibilities, then, the Pterygota may have been derived from an apterygote stock (1) in which the paranotal lobes were absent or repressed or, (2) in which they became reduced as the wings continued to increase in size or, (3) in which the primary absence of paranotal lobes perhaps stimulated the development of the wings.

#### *Pretracheation theory of Comstock-Needham*

Few works have influenced entomology as deeply as has "the Wings of Insects" by Comstock and Needham (1898-1899) and again by Comstock ('18), in which the authors homologized wing venation between insect orders (for the more complete analysis and historical account see Carpenter, '66). But however much the work contributed in its time, it also introduced several errors, which are as follows: interpreting the wings as if tracheation determines the position of the veins; the assumption that the tracheation in nymphal wing pads recapitulates the venation of adult ancestors; the failure to recognize corrugation and richly ramified venation as primitive and phylogenetically important features; and the overlooking of the crucial significance of fossils for the detection of missing or fused veins and for clarifying the venation pattern.

All these misinterpretations were closely linked, and have confused some plesiomorphic

and apomorphic characters of venation. The "archetype venation" models of Comstock-Needham (1898), Bradley ('39), Snodgrass ('35) and their numerous followers do not, by any means, reconstruct a primitive venation. For that reason they were frequently challenged by paleoentomologists (see Sharov, '66, for summary). Some designations of veins, used occasionally by some present authors, are only typologically based and cannot be used for broader comparisons and homologization; examples are postcubitus (Snodgrass, '35), plical veins (Forbes, '32, '43), and plical and empusal veins (Hamilton, '71-'72).

The primary role of blood channels (rather than that of tracheae) for a determination of the venation was suspected by Šulc ('11), Marshall ('13), Kuntze ('35), and Ross ('36). This concept has been recognized and supported by several authors using the approaches of histology, experimental teratology, ontogenetic analysis, comparative morphology, and circulatory physiology (Tower, '03; Holdsworth, '40, '41; Henke, '53; Smart, '56; Whitten, '62; Leston, '62; Arnold, '64). The idea has similarly been supported by paleoentomologists, as in many papers by Tillyard, Martynov, Carpenter, and Sharov. Yet, almost unbelievably, in the most commonly used entomological textbook in North America, Borror and DeLong (editions from 1954 to 1976) and in some other recent textbooks, the venation of Odonata is interpreted according to the "pretracheation theory." Consequently the "media" comes out "crossing" the "sector radii," which is never the case among the Pterygota and creates the false impression that the dragonflies are thus unique.

The precursors of the veins in the nymphal wing pads are the lacunae, free spaces which are surrounded by the spongy columnar epidermal cells (figs. 3, 4). According to Holdsworth ('40, '41), tracheae and nerves grow into these channels only *after* their pattern has been established. The veins are secreted by the epidermal cells through deposition of cuticular material above and below lacunae only at the final nymphal/adult moult. During ontogenesis, the position of tracheae *may or may not* reflect the future venational pattern. Wing tracheae may increase in number at each ecdysis, and new tracheae may grow out into areas deprived of oxygen (Wigglesworth, '54; Locke, '58; Smart, '56); tracheation may also be influenced by temperature (Henke, '53). According to Whitten ('62), each instar

(including the pupal stage), possesses its own tracheal system which may more or less differ from that of the next instar and from the adult stage. The tracheal pattern is not necessarily homologous between instars, because new additional tracheal branches may be formed and old ones discarded. However, there is still a degree of stability and if no changes occur in the areas to be served, the tracheae probably follow a constant developmental pattern (Landa, '48; Henke, '53; Whitten, '62). According to Whitten ('62), at a generic or family level, wing tracheation in some insects is stable enough to be helpful in the study of the venation pattern. Attempts to deduce phylogenetic trends on the supraordinal level have, however, been unsuccessful. It should be noted that the particular tracheae, which serve the wing, never "migrate" or "fuse," as has been erroneously brought forward by Comstock and Needham (1898-1899) (this occurs solely in the tubular venation).

In almost all insects, each fore and hind wing is served by two tracheae (Whitten, '62): the anterior trachea, which supplies oxygen to the costo-median venation; and the posterior trachea, which supplies the cubito-anal venation. The anterior trachea arises from the region of the spiracle located anteriorly to the wing in question, the posterior trachea from the spiracle located posteriorly (since the prothoracic spiracle has been completely lost in all living adult insects, the mesothoracic spiracle became anterior and the metathoracic became posterior with regard to the fore wing; the hind wing is supplied from the metathoracic and the first abdominal spiracles). The dividing line between two tracheal metameres (tracheations of primary body segments) runs into the wing between the anterior and posterior trachea. As shown by Whitten ('62), both pairs of alar tracheae moult with their respective spiracles, i.e., within their two different segments. The only exception are the Ephemeroptera in which all veins, including the cubito-anal system, are served only by the anterior trachea from the anterior spiracle. Whitten ('62) correctly concluded that the *cubito-anal tracheal branches in Ephemeroptera are not homologous to those of any other insect order*. The question is whether this condition is primitive or derived.

Deductions should be built upon the fact that in the primitive stage, each insectan somite (metamere, primary body segment)

was independently tracheated from its own pair of spiracles (Snodgrass, '35). In the embryo, the tracheae start intrasegmentally, as paired ectodermal invaginations. This segmental condition is well expressed in primitive apterygote insects (machilids). In the pterygote body, the complicated tracheal network (longitudinal anastomoses and transverse commissures) resulted from connections of the primary segmental tracheal systems, at first probably to give more efficient aeration. Accordingly, structures like legs receive additional air supply from the spiracle on the following segment; the posterior part of the wings is served by a side branch which diverged from this secondary leg-trachea.

Contrary to the above, tracheation in Ephemeroptera is restricted in each somite to that of its own spiracle. This condition is most likely to be close to the archetype stage, and thus to be *more primitive than that of the other Pterygota* (for more detailed documentation see Weber and Weidner, '74). Previously, some doubts were cast on this obvious conclusion. These doubts stemmed mainly from several reports of "residual remnants" of posterior tracheal branches in some mayflies (Kristensen, '75, for discussion). However, these data must have been mistakenly observed for the following reason: Whitten ('62) showed that whenever anterior and posterior alar trachea come into contact, there is a structure called tracheal nodus. Thus, *the tracheal segmental systems do not fuse, as is often erroneously stated, but connect at tracheal nodi which again disconnect at ecdysis*. Since such a nodus is missing from the alar tracheal system of Ephemeroptera, each system moults with, and consequently belongs to, only one somite.

Another question is the timing of the invasion of the posterior alar trachea into the cubito-anal system of Pterygota. Segmental tracheation is present in primitive Apterygota and must have been present in the paleopterous ancestors of Paleoptera and Neoptera, because it occurs as relic structure in modern Ephemeroptera. We have no way to estimate when and how many times occurred the invasion of posterior trachea into the cubito-anal veinal system. However, it is probable that at least in Odonata and Neoptera the double alar tracheation resulted independently, from parallel evolution.

The fossil record is not very helpful in documenting the events of tracheation, because

the crucial basal tracheal branching is within the thorax and is not preserved. However, some results may be drawn from the venation of Paleozoic nymphs which can be compared with the tracheation of old modern nymphs and metamorphic instars (true tubular venation of Paleozoic nymphs corresponds to the invisible blood lacunae in the wing pads of modern nymphs, which in both cases hold the tracheae). It should be noted that the veinal pattern near the wing base of Paleozoic mayfly nymphs (fig. 2) closely resembles the tracheation pattern in primitive modern nymphal mayflies, such as Siphonuridae. If this cannot render the proof that the alar tracheation of some Ephemeroptera stayed almost unchanged since the Paleozoic, it is at least indicative of this conclusion.

To summarize present knowledge: tracheae serve the wings by delivering oxygen and develop in the pattern established by the incipient venation, but tracheae never indicate the course of the veins. In some insects, the tracheation is quite stable and may turn out to be helpful, especially in older instars, in understanding venation on an infraordinal level. However, since tracheae never fuse and never migrate (but veins do), the terminology and principles used for venation are not fully applicable to tracheation, as is often erroneously practiced. Tracheation inside of nymphal lacunae does not recapitulate the macroevolutionary events of the wing venation; this can be found only in the venation of fossil insects.

#### *Spiracular flap theory*

Bocharova-Messner ('71) considered the possibility that wings originated from integumental evaginations which at first served as spiracular flaps. Data for this hypothesis were drawn from her study of wing development in Odonata (Bocharova-Messner, '59) (fig. 36). She suggested that the small spiracular flap first achieved mobility by acquiring muscular and sensory mechanisms to aid in respiration. The primary function of the integumental evagination above the spiracle was tactile and exploratory. Later, a larger fold developed to protect the spiracle and to create a chamber around it. With time, the fold enlarged and became mobile, perfecting the protective function. Eventually it became large enough to serve as a ventilating mechanism for the tracheal system. With this newly acquired function, the mobility of the fold continued to improve and the respiratory muscles became

involved. The flap flattened, increasing its ratio of surface area to volume, and at this stage it started to help with forward locomotory movement. Gradually, the leg muscles came to coordinate the motion of the legs and flaps. The evolutionary process finally resulted in the formation of a mobile, flattened appendage with a high frequency of beating which was helpful in rapid running, and had the potential of later becoming mechanized for flying. This detailed resumé of Bocharova-Messner's ('71) paper is given because her interesting spiracular flap theory is practically unknown to most English-speaking entomologists.

This hypothesis brings several intriguing aspects to our attention, such as: the possibility of a primary exploration-inspection role of the wing evagination; the possible involvement with regulating the closure of the atrium and thus gas exchange in the trachea; and the possible participation of the pre-wings in running. If the evagination first formed a spiracular flap, this would probably be a new structure, analogous to a flattened spur. The current fossil evidence neither proves nor disproves the spiracular flap theory, but there are at least two features which might be interpreted as supportive: First, Permian mayfly nymphs, which were secondarily aquatic, typically had slender, long, cursorial legs (fig. 28) with long, 5-segmented tarsi. Similar or only slightly different (shorter) legs and tarsi were also present in Palaeodictyoptera and many other generalized Paleozoic insect orders. It thus seems quite likely that early (terrestrial) pterygote legs might have been well adapted for running. Second, it is important from an evolutionary viewpoint that ancestral (presumably semiaquatic) Apteriygota lacked a spiracular regulatory mechanism for the control of respiratory water loss. Control of body water content is extremely important for the survival of terrestrial (and especially of flying) insects. Therefore, it is almost certain that some kind of water regulation mechanism must have originated at about the same time as the wings, if we assume that the early pterygotes originated on dry land.

Bocharova-Messner's spiracular flap theory seems debatable on the basis of spiracular distribution. The largest number of spiracles found in modern adult insects is ten pairs: two thoracic and eight abdominal. The first spiracle is often on the prothorax, but is meso-

thoracic in origin. The true prothoracic spiracle was lost. When less than ten functional spiracles are present, the "non functional" ones persist and open at the time of ecdysis and permit the cast intima to be shed (Chapman, '69). How does this number and position of existing spiracles agree with the fact that some fossil insects have three thoracic wings and that the maximum number of abdominal winglets so far documented in Neoptera is ten (in juvenile plecopteroid Protorthoptera, fig. 35), and in Paleoptera is nine (in juvenile Ephemeroptera, fig. 28)?

According to Snodgrass ('35), spiracles have been found on 14 insectan segments; they are the second maxillary segment, the three thoracic segments, and the first ten abdominal segments. Wheeler (1889) detected 12 spiracles (3 thoracic and 9 abdominal) in the embryo of *Leptinotarsa decemlineata*. This observation was later repeated and confirmed by Tower ('03). According to M. H. Ross ('64) true prothoracic spiracles may also occur in mutants. In newly hatched nymphs of mutated *Blattella germanica*, these appeared anteriorly on the prothorax, close to the cervical membrane. Even though the openings quickly disappeared, their position was marked as a meeting place of a number of tracheae, like those of the permanent spiracles. Consequently, ancient insects probably had a pair of spiracles on each body segment, as was previously deduced by Snodgrass ('35).

In his detailed work on larval wings, Tower ('03) repeatedly found incipient wing-discs in Coleoptera, Lepidoptera, Orthoptera, Blattodea, and Hemiptera in exactly the same position, close to and above the spiracle. Finally he became convinced that "the wings are derived in some way from the tracheal system." This statement might be also interpreted as support for the "spiracular flap theory."

#### *Stylus theory*

Wigglesworth ('73, '76) has introduced a novel hypothesis suggesting that wings originated from the coxal styli of Apterygota. He assumes that the thoracic wings are homologous with the abdominal gill-plates of mayfly nymphs and with the abdominal styli of apterygotes, which he considers to be serially homologous with the coxal thoracic styli of Archaeognatha. This homologization is disputable and is contradicted here. However, there are several phenomena discussed below, which do favor Wigglesworth's homologizing

of the thoracic wings of mayfly adults with the abdominal gill-plates of mayfly nymphs, rather than with the legs (Snodgrass, '35; Imms, '64) or leg exites (Birket-Smith, '71):

1. Mayfly nymphal gill-plates are segmentally arranged, articulated, and moved by subcoxo-coxal muscles (figs. 26, 38). They are very different from the typically soft and floppy filamentous gills of other aquatic juveniles, which occur without a definite arrangement and which lack musculature. The main function of gill-plates is primitively 2-fold: to drive currents over the tracheated surfaces, and to *render aid in locomotion*. For the last, the leading margin is often strengthened as in thoracic wings (fig. 25A: am).

2. Mayfly nymphs never develop gill-plates on the thorax or head, but they do develop regular filamentous gills there.

3. In Paleozoic mayflies gill-plates were present on all nine segments of the abdomen (figs. 28, 30). The leg-derived gonostyli (claspers) in all mayflies are attached ventrally to the ninth segment; the vortex-like traces of nymphal abdominal wings, found in living adults by Birket-Smith ('71: fig. 1A), are located more dorsally, in a position serially homologous to the thoracic wings.

4. Mayfly gill-plates are articulated between the subcoxa, and the tergum (fig. 25A) like thoracic wings. This location is maintained, even if the gills are completely dorsal because of the lateral, expanded, and margined subcoxa (Crampton, '16, regarded this seemingly "tergal" position of the gill plates as strongly opposing their homology with thoracic wings).

5. In the gill-plates of modern mayfly nymphs, there are often remnants of a true venation (Woodworth, '06; Needham et al., '35; Wigglesworth, '76; Landa, personal communication) as in thoracic wings (compare figs. 25A and 28). Moreover, in Paleozoic mayfly nymphs (fig. 28), the venation of gill-plates serially repeats the whole (but simplified) venation of the thoracic wings. This evidence of serial homology in venation pattern should be regarded as important.

6. In their ontogenetic development, gills begin to occur in the second or third instar. According to Dürken ('07, '23), they evaginate from the body wall (fig. 38) as do thoracic wings. He considers the gill-plates to be *new structures which are not derived from the terga*. After evagination, the gills migrate closer towards the posterolateral angle of

the tergum. The same process of migration takes place in the incipient thoracic wings of modern generalized nymphs (fig. 36), (Bocharova-Messner, '59, '65; Tower, '03). The gill-plates might be doubled, but both lobes stay attached to the single common base.

7. According to Snodgrass ('35, '52) the gill-plates are supported by two lateral sclerites, located between the tergum and the sternum. They are articulated to the dorsal sclerite, while the muscles extend between the gill-base and the ventral sclerite (figs. 25A, 38). If we agree with Börner ('08) that the dorsal sclerite is the subcoxa, and with Wigglesworth ('76) that the ventral sclerite is the coxa, then the muscles moving the gills are the subcoxa-coxal muscles. The same muscles in the thorax are stretched between the wing base and coxa and serve as direct flight muscles.

8. The abdominal wings (gill-plates) of mayflies are articulated to the subcoxa and are always located above the level of the (obliterated) spiracle, like all pterygote thoracic wings. On the other hand, the leg-derived gonostyli, styli, cerci, and gill-legs (tracheopods) of some nymphs are articulated to the coxae (Snodgrass, '35; Smith, '70a,b), always below the level of the spiracle. This shows the duality of the abdominal appendages in Paleoptera, as well as the pronounced serial homology of all body segments, which is frequently unexpected and thus overlooked.

9. To summarize the data: the gill-plates of mayflies are segmentally arranged abdominal appendages, always located above the spiracle, which evaginate and develop very much like the thoracic wings; they are also provided with true venation, articulated between the subcoxa and tergum, and moved by the subcoxa-coxal muscles like thoracic wings.

Following workers (see Landa, '48, for full citations) believed that the gill-plates are serially homologous with wings: Gebenbauer (1870), Lubbock (1873), Brauer (1882), Palmen (1887), Simroth (1891), Voss ('03), and Woodworth ('06). More recently, the same view has been taken by Wigglesworth ('73, '76) and Matsuda ('76). An identical conclusion was reached here on the basis of the fossil evidence.

Abdominal wings are not restricted to the Ephemeroptera, but they occur also in some extinct Neoptera, in young as well as adults. So far, they have been described in the nymphs of plecopteroid Protorthoptera from the Lower Permian of Elmo, Kansas (Car-

penter, '35), but I have seen other fully winged protorthopterous nymphs of various types, from the same locality (figs. 35, 48). In opposition, modern Neoptera do not show appendages equivalent to the abdominal wings. According to Zwick ('73), the ventrolateral segmented abdominal gills known in some modern Plecoptera (Eustheniidae, Diamphipnoidae, Pteronarcidae, and few primitive Perlodidae) are situated *below* the spiracular scar and therefore cannot be homologous to wings; neither are they homologous to legs, because they develop independently from abdominal limb buds (Miller, '40). Thus, there is evidence in Paleozoic insects, but no readily apparent proof in modern insects, that the vestigial abdominal wings were primitively present on the abdomens of Neoptera.

The serial homology between (1) the wings and (2) the abdominal styli of Apterygota and some larval Pterygota (Megaloptera, some Neuroptera, Coleoptera and Zygotera), as proposed by Wigglesworth ('76), cannot be accepted. In Pterygota, the thoracic wings are always found *above* the spiracle (i.e., dorsally at the subcoxa) while the legs are always *under* the spiracle, i.e., within the coxal region (Snodgrass, '35). The same conclusion has been confirmed by Landa ('48) on the basis of tracheation: his section through an abdominal segment of a mayfly nymph shows the intermediate position of the spiracular trachea *between* the vestigial leg- and gill-plate tracheae (fig. 40). Moreover, the telopodite-derived body appendages, legs, styli, gill-legs (tracheopods), gonostyli and cerci, are never known to migrate above the level of the spiracle in order to articulate or fuse with the tergum, as is routinely done by incipient gill-plates and wings.

Even though the position of mayfly gill-plates in relation to the spiracles cannot be externally observed (the spiracular openings were lost when ephemeropterid nymphs switched to apneustic respiration) it is nevertheless well known. As described by Dürken ('23) and Landa ('48), the anlage of the future adult spiracle is clearly indicated by the tracheae, and the gill-plates are always located above the spiracular level, as shown in figs. 37, and 40. According to Birket-Smith ('71: fig. 1A) the abdominal wings are indicated in the adults of primitive *Povilla adusta* by a vortex-like trace. This is also located *above* the spiracular level, while the gonostyli in the same species are *under* the spiracle.



In the modern literature, the abdominal styli, gonostyli, and cerci are interpreted either as coxal exites or as reduced legs. Lately, Smith ('70b, '76: XV. Int. Congr. of Entomology) considered that maxillary and labial palpi, gonostyli, abdominal styli and cerci are serially homologous with complete telopodites (legs). He believes coxal styli of apterygotes to be coxal *endites* that have rotated somewhat outward, i.e., they are not homologous with abdominal legs. There is some fossil evidence for the primitive arrangement of the leg-derived abdominal appendages in Pterygota: adult terrestrial Diaphanopteroidea (extinct Paleoptera) in my undescribed material from the Lower Permian of Czechoslovakia have a series of segmented styli on the abdomen. Probably the segmented abdominal vestiges of legs were inherited from Apterygota and were primitively present as a plesiomorphic feature in all abdominal segments of early Pterygota. Many of these leg-derived appendages were carried over to living insects and fulfill different functions.

In the modern insects, vestigial abdominal legs are randomly preserved as cerci, styli, tracheopods (gill legs), and gonostyli throughout the pterygotes (the larval prolegs of holometabolous insects are not serially homologous with the legs: see review in Hinton, '55). They are especially long and conspicuous in aquatic juveniles of corydalids, sisyrids, and probably in some damselflies, in which they sometimes are reported to retain a segmentation and musculature comparable to that of the legs (Matsuda, '76). In aquatic habitats, the tracheopods are useful in locomotion, as respiratory gills and as tactile organs.

It is highly probable that *all Pterygota* primitively had two sets of vestigial lateral abdominal appendages, the equivalent of wings (figs. 28, 47) and legs, occurring serially on all segments (fossil material supporting this point will be discussed in detail later). In modern pterygotes this ancient and serial dualism in lateral appendages is fully preserved in the meso- and metathorax, and is sometimes clearly expressed in the prothorax, but is obscured or obliterated in the abdomen. It is well documented (Kukalova, '68), however, that primitive fossil mayflies had nine pairs of wing-derived gill-plates. In the males of modern Ephemeroptera the leg-derived gonostyli are still present on the ninth segment. Further evidence of serial dualism in the abdomens of Paleozoic plecopteroid Protor-

thoptera from Elmo, Kansas, is in preparation.

In Wigglesworth's ('73) hypothesis insect wings are derived from the coxal styli of apterygotes, so that in ancestral pterygotes the basal parts of the coxal limb bases (i.e., subcoxa: Snodgrass, '35) of the thorax became incorporated into the thoracic wall to form the pleuron, while the sites of articulation have migrated dorsally to the margin of the notum (Wigglesworth, '73, '74, '76). According to Smith ('76: XV. Int. Congr. of Entomology) the primitive apterygote subcoxa was already differentiated from the coxa and formed an annulus, as on some head appendages and on the meso/metathoracic legs of fossil *Monura* and modern *Archaeognatha*. It is therefore probable that the subcoxa was previously free from the coxa *before* it became incorporated into the pleural wall. Since the coxa remained associated with the telopodite, the subcoxa of the earliest Pterygota was bound to be in the way of any potential migration of the coxal stylus.

From the paleontological viewpoint, Wigglesworth's ('73) hypothesis would be more credible if the annular subcoxa itself bore a movable appendage (exite) *before* it became part of the pleural wall (subcoxal appendages are known in some primitive Crustacea and Chelicerata). The similarity of the pleuron in some Apterygota (*Thysanura*) and Pterygota can most probably be explained by parallel evolution. It should be noted that the possible origin of wings from a structurally "old" arthropodan appendage on the upper part of the leg, is supported by two ancient and potentially significant links: the primitive wing was tracheated by a branch directly derived from the leg trachea and was moved by the leg muscles.

#### *Fin theory*

Bradley ('42) attempted to explain the old enigma of why the pre-flight wings, while still too small to support an insect in the air, continuously evolved characters necessary for (future) flight, such as an increase in size, and the development of venation, flight musculature, and a complicated articulation. According to his hypothesis, ancient primarily terrestrial pterygotes became amphibiotic and more and more adapted for excursions into the water. However, they were probably capable of leaving the water for purposes of mating and dispersal. Thus, the little pro-wings which would have had little or no effect in air, could

have been highly useful as fins and propulsion organs in water. In the process of using pro-wings as fins, the hinge and flight musculature began to develop. An identical idea, inspired by the mechanical efficiency of pro-wings rowing in the water, was independently presented by Grant ('45).

At the time that Bradley ('42) formulated his "fin theory" of wing preadaptation, two later contributions of fossil evidence were unknown: 1. That all primitive Paleozoic nymphs had articulated and movable winglets throughout their ontogenetic development (Sharov, '57a,b, '66, '71a,b; Carpenter and Richardson, '68; Kukalova, '68; Wootton, '72; Kukalova-Peck and Peck, '76). 2. That the Paleozoic aquatic mayfly nymphs probably did use their articulated, lateroposteriorly extended wings like fins, as he anticipated for the early pterygotes (figs. 28, 30). Consequently, Bradley's hypothesis, even if it erroneously explains the origin of the wing itself, seems to somehow conform with the fossil evidence in the origin of flight.

Bradley's ('42) and Grant's ('45) view that the aquatic environment promoted a propelling function in small (nymphal) wings finds support in the fossil record. It is quite evident that use of the wings in some Paleozoic nymphs under aerial conditions was already decreasing. Thus, the wings in all terrestrial juvenile roaches were completely flightless. Some nymphal wings in Palaeodictyoptera, as judged by their general shape and position (figs. 22, 24), were in the process of rapidly losing their ability to function. At the same time, aquatic ephemerid nymphs used their wings for promoting forward motion under water (figs. 28, 30).

In opposition to the aquatic origin of wings, H. H. Ross ('55) introduced the following facts: almost all living, generalized insects have normal functional spiracles in the immature stages, and hence they were necessarily also present in the juvenile ancestors. Aquatic juveniles became independently different from their early ancestors (by loss of spiracles, etc.) and cannot represent an ancestral stage. In spite of the fact that Ross' statement is true (Paleozoic mayfly nymphs have long, cursorial legs with no trace of any adaptation for an aquatic environment; the obliteration of spiracles in Recent aquatic nymphs is distinctly secondary, etc.), his reasoning is wrong and cannot disprove the possible aquatic ori-

gin of wings. As shown below, the amphibiotic life in insects (or in other animal groups) is not bound to cause distinctly aquatic structural adaptations.

A proof that spiracles are not completely lost during aquatic adaptation in even Recent Ephemeroptera is provided by Dürken ('07) and Landa ('48). In younger instars, all spiracular tracheae (tracheae that are connected to the spiracles) collapse and are marked only by a barely visible internal strand (figs. 37, 40). An opened trachea is temporarily formed before each molt and the lumen closes again after the old trachea has been removed with the exuvium. In the later instars, however, the first and second thoracic spiracles do not vanish and their spiracular tracheae do not collapse. Instead, the spiracles are only tightly mechanically closed (fig. 39). Therefore, the thoracic spiracles of older ephemerid nymphs have persisted through more than 250 million years of aquatic adaptation. Similarly, in the nymphs of Odonata, the abdominal spiracles are closed, but the thoracic spiracles do open and function in the final instar, before metamorphosis takes place (Corbet, '62). Hence, we should keep our minds open to the possibility that ancestral pterygotes were fully capable of switching their environments and of thus exposing the wing structures to varied functions and adaptations; it also should be noted that amphibiotic life has led to the evolution of important organs in many other groups of animals.

#### *Gill-cover theory*

The gill-cover theory by Woodworth ('06) to some extent bridges the previously discussed "spiracular flap theory" which associates the origin of wings with respiration, and the "fin theory," which promotes the aquatic habitat as the stimulator of pro-wing development.

In the gill-cover theory, the origin of wings is assumed to have been conditioned by a change of habitat, when a formerly terrestrial insect became aquatic. In a small insect, of about the size of a young mayfly or dragonfly nymph, the only necessary adjustment would be a reduction of the thickness and firmness of the cuticle, because cuticular respiration provides a sufficient supply of oxygen. However, increase in size necessitates a substantially larger intake of oxygen as well as a hardening of the body wall for muscle attachment. Therefore, respiratory structures in larger in-

sects become localized and improved by adaptations of the body wall.

Gills, as the organs of aquatic respiration in insects, are in their simplest form any outgrowth of the body wall that retains the soft texture originally possessed by the whole body surface. The simplest outgrowth (blood gill) becomes much more efficient if served by a tracheal twig. Clusters of filamentous gills tend to grow around the limb bases and other protected but well ventilated areas. However, a great many insects assist respiration by vibrating the body and by continuously bathing the gills in water currents. When an insect possesses articulated covers protecting filamentous gills, water circulation may be provided by movement of the covers. With such covers, older individual nymphs could have reentered the terrestrial environment (if their body cuticle hardened and their mechanically closed spiracles re-opened) and take advantage of these mobile, lateral appendages. Thus, mobile gill-covers may have been preadapted for use as wings.

In his well documented study, Woodworth ('06) was inspired by the abdominal wings (he called them gill-covers) of some mayflies, which actually function as opercula for the filamentous gill-clusters, protect them from being clogged with silt in turbid water, and provide for them a circulation of water. He noticed that these covers are stiffened by a real venation, and the veins are even indicated by rows of spines as in flying wings, to which they bear a striking resemblance (fig. 25A). However, he pointed out the difficulty in explaining why, in ontogeny, there is the repression of wing development until the final molt of the metamorphic instar (the essential prerequisite to the gill-cover theory is the vigorous function of the gill-covers during the whole juvenile phase). This "inconsistency" is only seeming and is explainable on the basis of fossil evidence.

The present fossil record complements Woodworth's data by revealing the venational pattern in the Paleozoic abdominal wings, which is much better preserved than in modern mayfly nymphs and is even comparable with that of the thoracic wings (fig. 28). The repression of the nymphal wings is shown to be the *derived condition* which occurred only after the wings were fully established as efficient flying organs in the adults (figs. 29, 30). In the primitive ontogenetic development

the wings were continuously movable and the increase in their size between the first instar and the adult was completely confluent (figs. 6, 30, and unpublished material) and the metamorphic instar was missing. Thus, because of morphological reasons, there is a strong indication that the wings did originate in the nymphal stage and can be explained only through the possible function and benefits that *they brought to the juveniles*, as Woodworth fore-shadowed in his gill-cover theory.

#### *Synthesis of ideas on wing evolution*

In the preceding text, four theories on wing origin are mentioned that are acceptable, at least partially or with some modification, in the light of the present fossil record. Bocharova-Messner, ('71) in the "spiracular flap theory," seems to have explained why the wing buds are always found near and above the spiracles in view of the fact that the insects were primitively terrestrial and had cursorial legs. Woodworth ('06), in the "gill-cover theory," probably provides the most acceptable reason for the rapid evolution of the small pro-wings, once some insects entered the water (through their generation of respiratory currents), as well as for their placement above the spiracle. Bradley, ('42) in the "fin theory," gives the most likely explanation for the perfection and coordination of the base-rotation musculature essential for flight in the larger pro-wings. Wigglesworth, ('73) in the "stylus theory," suggests why the wings are moved by the subcoxo-coxal musculature and why they give in many respects an impression of being "old structures." Further investigation is needed to support or reject any particular possibility or any combination of them and the question is still open to hypotheses.

I now take the opportunity of summarizing the above ideas and of offering a new reconstruction of the origin of wings and flight. For more detailed discussion of the fossil record and the origin of metamorphosis, the reader is referred to section IV of this paper. It is of prime importance to remember that wings arose only once (as shown by the remarkable degree of uniformity of wing characters) in arthropods, which are otherwise notorious for the repeated and independent origin of very complicated structures. As emphasized by Woodworth ('06) and Wigglesworth ('63), this event must have been exceptional and was fol-

lowed by extraordinary and potent selective pressures favoring the growth of the pro-wings; otherwise wings would not remain, among arthropods, unique to insects and/or would not have developed.

Equally as important to this subject is to set the scene by the reconstruction of the environment in which the early insects lived. Mamajev ('71) points out that the most ancient terrestrial plants — Psilophyta — (known first from the Upper Silurian) were moisture-loving, growing only in the high humidity of rainy primeval "swamps." This was the only available (but discontinuous) environment with "terrestrial" vegetation, and the apterygote insects probably originated and lived in it. Very likely they inhabited moist niches and were "semiaquatic," as they often still are today. They probably fed on decaying plant tissue, aquatic algae, and organic debris and some of them were possibly predators on small organisms. By the Middle and Upper Devonian plant stature had increased and "forests" existed, with some small quantities of leaf fall. Under these circumstances, there was probably a strong pressure on the presumably semiaquatic phytophagous insects to reach the more leafy and tender parts of these taller plants. In the patchy (and possibly temporary) early forest habitats, the insects which came to possess flapping lateral appendages had a distinct selective advantage in their ability to escape, to break a fall, and to disperse. In patchy habitats, dispersal through the utilization of air currents, soaring and flapping flight might have carried a crucial survival value (Wigglesworth, '76).

Wings are movable evaginations of the body wall above the spiracle and below the tergum. In the early pterygotes, they were present on all body segments. The wings might have started as new structures, analogous to spurs, which were adapted as spiracular flaps or movable gill-covers, or they might represent old transformed structures. They could have first served as regulatory respiration mechanisms in a closing of the spiracles during temporary excursions into water and as an operculum preventing respiratory water loss after the insects took to the trees. Or they could have protected the gill tufts and bathed them in water currents, or served as lateral tactile organs as, by analogy, do the coxal styli in modern bristletails.

In this first period of their existence, the sack-like pro-wings became flattened, the

haemocoel was restricted to channels, and the basic subcoxo-coxal musculature was developed. Later, the channels became cuticularized and sclerotized, and changed into a stiffening venational framework. In this early stage of evolution the veins became slightly rippled, and thus the pro-wings gained additional mechanical strength. Eventually the pro-wings became large enough to be capable of promoting forward motion and diversified into the three larger thoracic and the smaller abdominal pro-wings. At this stage, the ancestral pterygotes might have been amphibiotic, and therefore these first propelling attempts perhaps happened during underwater excursions. It should be noted that the ancestral pterygotes very probably had cursorial legs with five tarsal segments, short leg-derived cerci (long cerci in silverfish, Palaeodictyoptera and mayflies are secondary specializations) and a caudal filament longer than the cerci. Therefore, auxiliary propulsion by fin-like pro-wings was much more important in primitive forms than it would be in any modern aquatic nymph. In adapting to underwater rowing, the pro-wings had to become larger, and further cuticularized, and the wing-plane more deeply corrugated for additional strength. The rowing pro-wings also had to be equipped with mechanized venation, a rotating base, and coordinated musculature, three features which are also essential for forward flight. When these insects took to climbing vegetation to feed, mate, and disperse, they had an ametabolous ontogenetic development like modern Apterygota. Their ontogenetic series included many nymphal and subimaginal instars, so that no metamorphic instar was necessary. The pro-wings were latero-horizontal and paleopterous.

The forms which were equipped with the largest and best coordinated pro-wings had the better chance of survival, because the old nymphs and adults could use them for breaking a fall, prolongation of aerial excursions, attitude control, etc. Finally, the wings reached the size where they could be employed in active flight and the Paleoptera, as an adaptive grade and taxon, became established. The wings of the first Paleoptera were hinged to the body along a simple, straight line and could not be flexed backwards over the abdomen. Their ontogenetic development was still confluent (ametabolous), but now became subjected to strong selective pressures: The adults, in which the size of the wings was suf-

ficient to keep them airborne, were pressed to further improve flight capabilities. The young instars, which were unable to fly and had to escape through vegetation or by hiding, were pressed in an opposite direction, to change the impeding latero-horizontal position of the wings, and to develop additional aids to locomotion through specialization of structures like legs, tails, body movements, and anal jets.

This "streamlining" evolutionary trend in the juveniles of most Paleoptera caused the wings of early instars to grow in a curve with the tips directed backwards. This wing curve, also called the "nymphal wing bend," in the older instars became more and more straightened at each moulting, until the adult latero-horizontal position was achieved (figs. 6a-f). In some other Paleoptera, the same trend caused changes in the alar articulation. Twice, at different times, a new group diverged from the paleopterous stock, capable of an active flexing of the wings backwards over the abdomen. In the first group, (fig. 46b), the third axillary sclerite was shifted into a pivoting position and all the hinge sclerites were rearranged into a V-shaped formation: this led to the origin of Neoptera and triggered the development of many peculiar new characters. In the second group (fig. 46a') the actual flexing mechanism was (somehow) different from the "neopterous" type and the resulting new order Diaphanopteroidea stayed paleopterous in all remaining characters. The trend to suppress the nymphal wings continued in both Neoptera and Paleoptera. The older instars, with intermediately-sized wings, were neither good "flyers" nor good "hiders" and therefore were thus most exposed to selective change. Eventually they were replaced by a metamorphic instar, which bridged the growing morphological gap between the juveniles and adults while the wings of younger instars lost their articulation and were transformed into wing pads fused with the terga. In some orders (i.e., blattoids), this process took place as early as in the Lower Carboniferous, in others (i.e., Ephemeroptera), later. Endopterygote Neoptera originated from early ametabolous exopterygote Neoptera (perhaps of a plecopteroid type) by reducing the wings, legs, and many adult structures to mere imaginal discs which became invaginated under the larval cuticle. The resulting larva was very different from the adult and able to invade extremely varied habitats. In a phylo-

genetic sense the ontogenetic development of Endopterygota does not differ from that of Paleoptera and exopterygote Neoptera.

#### *Introduction to wing venation and corrugation*

All integumental evaginations on the insect body, such as flaps, spurs, projections, or wings, are formed around an extended haemocoel or blood cavity. If the evagination becomes flattened, the remnants of the haemocoel are trapped between two layers of integument and eventually become restricted to channels which might protrude above the surface. These elevations of the epidermis and cuticle which conduct blood are usually not corrugated and are generally called veins. By this process, veins are produced in the telsonal plates of crustaceans, in the tails of damselfly nymphs, in the lateral expansions of galumnid mites, or elsewhere in double-walled arthropodan structures. It is believed here that insect wings started as flattened evaginations and that the *veins are derived from residual blood channels* between the two basement membranes of the integument. Such hypothetical, small flaps were not corrugated and perhaps adorned thoracic and abdominal segments of Lower Devonian ancestral pterygotes. The fossil record on this phase of evolution is lacking.

The earliest winged insects on record (Protorthoptera, Paoliidae) were found at the base of Upper Carboniferous in Poland and Czechoslovakia (Kukalova, '58). In their wings, the venation occurred as cuticularized tubes, the interspaces were formed by a dense cuticularized archdictyon and thick membrane, and the veins were corrugated into alternating ribs like a fan for more mechanical support. These earliest-known wings differ quite substantially from the hypothetical archetypal wing-flap. They were lighter, stiffer, and much larger because of cuticularization, sclerotization, membranization, and allometric growth; they were articulated to the body by a sophisticated system of pteralia and epipleurites; they were supported by tubular venation which formed a light but strong, mechanically efficient and intricately fluted framework; and the arrangement of this framework was definite and comparable to all known fossil and living winged insects. Hence, there is a big gap in the documentation of how the venation evolved from a disarranged, random pattern into a definite corru-

gated framework, homologous throughout the whole group of the Pterygota.

For classification of wing venation, the Redtenbacher System of nomenclature is employed in which six main veins are recognized (costa, subcosta, radius, media, cubitus, and anal). Redtenbacher (1886) used the primitive alternation of convex (+) and concave (-) veins to homologize the venation of Pterygota. Lameere ('23) noticed that there were originally two media veins (media anterior, MA; and media posterior, MP), and two cubitus veins (cubitus anterior, CuA; and cubitus posterior, CuP), one of each being convex and the other concave. Carpenter, in many papers which he summarized in 1966, dealt with the adaptive loss of convexities and concavities of some veins in most orders of insects. A contribution of the present account is that *each of Redtenbacher's original six veins is recognized as being primitively composed of two veins, a convex and a concave one* (fig. 45). I have found the full pattern of six pairs of veins so far in Paleozoic representatives of Palaeodictyoptera, Ephemeroptera, Odonata, Protodonata, Blattodea, Protorthoptera, and Orthoptera; it is probably a general feature which was present in the ancestors of all lineages. The remnants of the full venation pattern are also preserved in innumerable living insects, as discussed in section III of the present paper. However, this primitive pattern has been found *fully corrugated* only in ancient Palaeodictyoptera (in all other insects, 1A+ and 2A- tend to lose their corrugation).

Corrugation occurs to some extent at least in the metathoracic wings of all insect orders (figs. 5, 7-12). The corrugation or fluting of the wing membrane is caused by the alternate occurrence of convex veins appearing (in dorsal view) as cuticular ridges, and concave veins appearing as cuticular grooves. When the dorsal and ventral surfaces of the wing of a paleopterous insect, such as Ephemeroptera, are separated by soaking them in 10% KOH, it becomes evident that *all convex veins are always formed only in the dorsal membrane, and all concave veins in the ventral membrane* (Spieth, '32), (fig. 5); and that the corrugation is very pronounced. When Spieth's technique is used on various neopterous insects, all veins are impressed at least to some extent on both membranes as mirror images (Holdsworth, '41), and the corrugation is generally less pronounced in the central part of the wing (figs.

9-11). The questions then are: (1) Why is the paleopterous condition supposedly primitive and the neopterous condition derived? (2) How does the corrugation relate to the origin of flight? Is it a contributing cause or a consequence of flight? And, (3) how important is it for the function of modern wings?

Wing fluting in Paleozoic insects was generally more common and pronounced than in modern insects. *There were six orders of Paleoptera with a deeply corrugated venation*, only two of which have survived until Recent times. In the extinct Paleoptera, the veins were unreduced in number and the corrugation was deep and regular (fig. 7). In Paleozoic and in living primitive Neoptera, the corrugation is often more distinct than in the living specialized orthopteroid and plecopteroid orders. Wing pads in living nymphs, as a rule, are almost flat with faintly indicated surface ridges which do not represent true veins; however, the Paleozoic nymphs had a tubular wing venation which was functional as a supporting framework and was fully corrugated (figs. 29, 30). Also the venation in the small abdominal wings of Paleozoic Ephemeroptera was corrugated (fig. 28). Corrugation was present *before* the insect wing became mechanized for forward flight (fig. 14) (an important point which will be discussed in more detail later). As observed by Adolf (1879), Redtenbacher (1886), Lameere ('23), summarized by Carpenter ('66), the convex or concave position of the main veins is primitively homologous in all pterygote groups and evolved in the most primitive wings. In contrast, the reduction of corrugation is generally secondary and evolved as later adaptations to specific conditions of aerodynamics, wing-flexing, etc. Thus, the *Paleoptera represent a more primitive condition than that of Neoptera* (Carpenter, '76).

The flattening of venation in living Neoptera generally occurs in both branches of the media, in the sector radii, and sometimes in the anterior cubitus. In thick tegmina or elytra almost all corrugation is lost and the veins become flat (neutral), or nearly so (figs. 10, 11, 26). In hemipteroid orders, the media and the sector radii are fluted only weakly if at all. In the orthopteroids s. l., the anterior branch of the media is mostly neutral and never distinctly convex; the posterior branch is either concave, or flat (fig. 26), (Carpenter, '66). In the endopterygote orders, the convex anterior branch and concave posterior branch

of the media have been retained (Carpenter, '40, '66; Adams, '58), (fig. 9B).

The primary cause that started a chain of adaptations which finally led to the reduction of corrugation in Neoptera is believed here to be wing-flexing. This major evolutionary event prompted the rearrangement of a straight and primitive series of axillary sclerites into a V-shaped series, so that the flexure could occur around the revolving third axillary (see section III). It also brought new requirements for the musculature and finally for flight itself. All these changes were probably closely followed by the development of aerodynamic "passively deformable areas" which, according to Wootton ('76: XV. Int. Congr. of Entomology) are recognized by their leveled corrugation, and occur most frequently in the vicinity of the veins Rs, M, and CuA.

In some higher Neoptera, namely in specialized Diptera and some Hymenoptera, the corrugation of the central wing area became secondarily deeply accented. In higher Diptera it became even more intensified by the addition of a supplemental highly convex "spurious vein" which originated as a cuticular rib on the back of the permanent wing-fold (fig. 13: sv). This secondary "revival" of corrugation was brought about by the change of flight technique, as explained by Pringle ('75): The up stroke is accomplished in all insects indirectly, by a depression of the tergum. The down stroke in Paleoptera and primitive Neoptera is produced by direct (i.e., mainly subcoxo-coxal) muscles, attached to the base of the wing. The muscles attached to the basalare twist the leading edge downwards, while the muscles attached to the subalare produce the reverse twisting movement. However, in most Neoptera, the down stroke results indirectly from an elevation of the tergum and higher wing speed in higher Diptera and Hymenoptera is achieved by a special click mechanism in the wing joint; twisting (pronation and supination) of the wings occurs automatically as the scutal cleft between scutum and scutellum closes and opens and the wing rocks backward and forward over the main pivot of the pleuron. It seems very probable (though it is not yet fully explained on an aerodynamic basis) that the latter changes in flight technique described by Pringle ('75) are the main cause of the accentuated corrugation in higher Neoptera.

The intensity of fluting in higher Neoptera, although superficially similar to that of the

ancient Paleoptera (figs. 13, 7, 8), is secondary and highly adaptive and was derived from the more primitive neopterous type of corrugation, in which Rs and M were mildly flattened. This is substantiated by, among other evidence, comparing the corrugation of higher flies with lower flies and that of their ancestral order — the Mecoptera. In the opinion of Rees ('75) the mechanical properties of muscoid, hymenopteroid and other wings with deeply corrugated venation compare with those of regularly folded or tubularly reinforced beams. The varying depth of corrugation (figs. 8, 13) reflects the distribution of aerodynamic forces: the stout bars which sometimes occur near the wing base (fig. 7: abr; fig. 12: br) help to prevent fluted folds from opening out suddenly when under pressure, the same manner as the crossbraces in a corrugated roof of a building.

Characteristic in the evolution of the wing in all Pterygota is the early loss of corrugation in the anal area. Again, according to Wootton ('76, personal communication) the flattening is due to formation of aerodynamic "passively deformable areas." The secondary adaptation of the anal area for better flight by a leveling of its corrugation happened so early that only some primitive Carboniferous and Permian Pterygota show a distinct fluting of the anal veins, with 1A and its branches being all convex, and 2A and its branches being all concave (fig. 7), (Kukalova-Peck and Peck, '76). Usually both anal veins come to lie on an even topographic plane in Paleoptera as well as in Neoptera (figs. 9A,B). The leveling of the anal veins in primitive Palaeodictyoptera is distinctly related to the formation of the "anal brace" (fig. 7A: ab), the crosswise cuticular bar that is also present in Recent Ephemeroptera (Kukalova-Peck, '74) and which prevents the anal area from buckling.

The corrugation of the principal veins described above should not be confused with the auxiliary corrugation formed by secondary intercalated veins, also called intercalary veins or sectors. These veins are formed from reticulations and often multiply the fluting in a direction opposite to that of the main veins (Martynov, '25; Sharov, '66; Wootton, '76). This type of secondary corrugation is most evident in the enlarged anal fans of the hind wings, especially of orthopteroid insects, and randomly in other groups. The presence or absence of intercalated veins is rarely indicative of close phylogenetic relationships above the

generic or even the specific level. However, in dragonflies and mayflies, they are apparently exceptionally important and ancient apomorphic features.

One or two anterior branches of 1A immediately proximal to CuP which are present in blattoid hind wings were called the "second plical vein" by Forbes ('43), (fig. 26). At the same time, his "first plical vein" is, in phylogenetic homology, the cubitus posterior (CuP), and his "third plical vein" is the posterior branch of 1A. This kind of superimposed terminology is confusing because it replaces homologous veins of the basic pterygote scheme (CuP, 1A) by uniquely topographical terms. Other confusing terminologies were introduced by Snodgrass ('35) and Wallace and Fox ('75) who called 1A of some Neoptera the "postcubitus"; by Smart ('51) who interpreted 1A in fore wings and the anterior branch of 1A in hind wings of roaches as a "postcubitus"; by Hamilton ('71-'72) who designated the cubitus posterior (CuP) in pterygotes as the "plical vein," the first anal (1A) as the "empusal vein," and the second anal (2A) as the "first anal vein"; and by others. Since the phylogenetic identities of CuP and 1A throughout Pterygota are known (see paleontological literature of the past 30 years; Brues et al., '54; Sharov, '66; and "Insects of Australia," '70), it would be a regressive step to revert to a typological and topographical terminology.

Corrugation does not "jump" from the dorsal to the ventral membrane, as is sometimes erroneously presumed. *The convex, concave, or neutral position of the main veins is phylogenetically based and well established* (Adolf, 1879; Redtenbacher, 1886; Lameere, '22-'23; Spieth, '32; and Carpenter, '40, '66). Changes occur slowly as a consequence of alteration in articulation and flight techniques. After an entomologist is acquainted with the position of flattened "passively deformable areas" in the more primitive (fossil and living) forms, he can use corrugation with confidence for correct interpretation of venation patterns in all taxa of his particular group of interest.

#### *Origin of wing corrugation*

In spite of the voluminous literature on wing corrugation, the timing of its appearance has been seldomly considered. The development of corrugation is generally presumed to have been synchronized with the development of flight, a seemingly well substantiated conclusion. Nevertheless, this deduction, drawn

from modern functional morphology, is not confirmed by the fossil record. On the contrary, indications are that fluting was already present in pre-flight wings, before the mechanization of the venation had even started.

A source of information on the possible morphology of pre-flight wings are the prothoracic winglets of Palaeodictyoptera (fig. 14). These were primitively movable and articulated to the tergum (fig. 1). The venation of the winglets was fan-like in arrangement and was homologous to that of functional wings but the shape and the distribution of veins was not at all mechanically adapted for flight.

How do we know that the palaeodictyopteran prothoracic winglets were incapable of producing forward flight? Pringle ('75) summarizes flight movements as follows: "In order to produce the aerodynamic forces of lift and thrust, flapping wings have to move with the stroke plane inclined to the vertical, and must make pronation and supination twists. . . ." In functional morphology it means that the flying wing must have a stiffened anterior margin, that is, the venation must be rearranged by having C, Sc, and RI lined up along the anterior margin. The prothoracic winglets of early Palaeodictyoptera might have been capable of flapping up and down, but they could not actively fly or scull forward because they were not so adapted. The most interesting feature of these leaf-shaped planes, however, is that they are *already corrugated* (fig. 14). This corrugation is weak but distinct (personal observation in 1977) especially in dictyoneurid Palaeodictyoptera from Commentry, France (Kukalova, '69-'70). Thus, in these cases at least, corrugation occurs not as a response to flight, but as a previous adaptation to another (yet unknown) kind of up-and-down movement which perhaps preceded flight.

Such pre-flight wings of ancestral pterygotes were apparently preadapted for flight in at least four ways: 1. in the presence of true, cuticularized, tubular veins; 2. in the corrugation which provided additional mechanical support; 3. in the presence of the reticulation between the veins which perhaps helped to strengthen the wings as well as to conduct blood; and, 4. in at least partial development of a hinge with sclerotized tergal sclerites and basivenales. All these features are also found in the wings of primitive Paleozoic nymphs (figs. 6a-c) which seems to give additional sup-



port (through recapitulation) to this concept of pterygote pro-wings. The fact that wing-corrugation preceded flight strengthens the conclusion that paleoptery was ancestral to neoptery.

Judging from the morphology of the prothoracic wings in Palaeodictyoptera, the slightly protruding haemocoel channels in the pro-wings of early Pterygota were at first spread fan-like and not fluted. They became further cuticularized and sclerotized, probably to reinforce the pro-wing by mass alone. The excretion of cuticular material became uneven and differential, so that the profile of the veinal tubes became asymmetrical when excess cuticle was unevenly deposited on the dorsal or ventral sides. The pro-wings then became rippled. The rippling was mechanically advantageous and favored by selective pressures. The pro-wings could become thinner and larger without losing strength. Because of the mechanical superiority of *regular* corrugation, the uneven deposition of cuticle became stabilized in a regular pattern; the blood channels which were incipient veins grouped together into six paired systems, each one connected with the body haemocoel by a single basal blood sinus. The anterior branch of each paired system became convex because of excess deposition on the dorsal side and the posterior branch concave through deposition on the ventral side. The process finally resulted in alternating ribs regularly protruding in opposite directions. The amazing regularity and symmetry in the vein-pairs, in their branching and corrugation, seems to correlate with the symmetrical leaf-like shape of the palaeodictyopteran pro-wing, as well as with the even fan-like distribution of the primitive veinal framework. All these features strongly suggest that the pro-wings were engaged in some function which required up and down movement (as spiracular flaps or gill covers).

The ripples, inconspicuous at first in the pro-wings, became crucially important after the juvenile winglets became involved in motion. In this process, the wings increased in size, the corrugation deepened, and the venation became mechanized. Finally a stage of development was reached whereby the corrugated wings could produce active forward flight.

The origin of fluting was attributed by Needham ('35) to the gathering together of the basal connections of the veins, and the narrowing of the base. We now know from the

fossil evidence (fig. 45) that the primitive wing-base along the primitive straight hinge was not narrow, and that the veinal base of each corrugated vein was flat. The whole alar part of the hinge was formed by the compact series of flat basivenales, so that there was no mechanical contact between the corrugated vein-pairs and the tergal pteralia. Forbes ('43), on the other hand, postulated that corrugation was a result of the articulation to the thorax, and the indirect action of muscles on a few principal veins. Again, this explanation does not conform with the fossil evidence. The primitive hinge line (h) separates pteralia of two morphological units, the thoracic and the alar (fig. 45). The flexible hinge is between the axillary sclerites, which are slanted mesad towards the paranotal sulcus, and the fused and flattened alar basivenales. These latter completely separate the corrugated vein-pairs from the axillary sclerites.

Most entomologists agree with Edmunds and Traver ('54) that the thinning of the wing-membrane, and the origin of fluting in the wings were simultaneous. To be capable of sculling flight the main wing blade had, first, to be thin and flexible. Secondly, it needed a firmer support than the veins themselves could provide. The necessary rigidity was secured by fluting. The relationship between thinning and fluting is well demonstrated in cross sections of various corrugated wings (figs. 7-9, 12): in thin membranous wings the corrugation is amplified by asymmetrical thickening of the dorsal part of convex veinal tubes, and of the ventral part of concave veinal tubes. In contrast, the corrugation becomes secondarily diminished if the cuticular veinal tubes are thickened symmetrically, as in tegmina and elytra, in both dorsal and ventral parts (figs. 10, 11).

According to Wootton ('76: XV. Int. Congr. of Entomology), "Insect wings, which are conventionally illustrated as flat planes, are really intricate 3-dimensional structures whose primary function is the translation of small axillary movements into complex flight patterns." In the pattern of the wing venation, he recognized "passively deformable areas," usually marked by diminished corrugation and "supporting/deformation areas," which are corrugated or otherwise reinforced. The relative position of these areas determines the angle of attack and the generation of useful aerodynamic forces. According to this explanation, an increase or a reduction in corruga-

tion follows closely after changes in the axillaries and other features of the wing that adapt to aerodynamic forces. Thus, the primitive flattened central part of the wing venation in Neoptera can be explained as a new "passively deformable area" and is an adaptive response to the changed arrangement of axillary sclerites.

What is not known is the reason *why* the pre-flight thoracic pro-wings became larger, thinner, and stiffened by a corrugated venation, and thus became preadapted for flight. There is no conclusive fossil material to indicate whether this process happened in the aerial environment, in the aquatic environment, or in a combination of both, and we are confined to mere hypothesis. However, the fossil record may, in the future, present more "down to earth" evidence.

#### *Flight efficiency*

The musculature used for primitive flapping flight was the subcoxo-coxal muscles, which were already present in the apterygotes. Therefore, the pro-wings were almost certainly movable long before the articular structures were fully differentiated and before the pro-wings enlarged in size. This succession is still reflected in development of the abdominal winglets of modern mayfly nymphs (Dürken, '23). As suggested by Ewer ('63) and Ewer and Nayler ('67), the primitive coordinating mechanism of flight movements might have stemmed from that used in running movements, and both running and flying could have been served by a common central nervous pattern of control; since flapping flight involves a well coordinated, complex program of muscular movements, it could not have arisen by some macro-mutation, as is sometimes proposed, but solely through gradual selection.

Most likely, the first excursions of insects through the air were by dropping to avoid predators or by being involuntarily blown from a high object by the wind (Zalessky, '53; Ewer, '63; Wigglesworth, '63; Hinton, '63; Flower, '64). In a study of the aerodynamic behavior of insects of different shapes, Flower ('64) showed that in larger insects the presence of even rather small pro-wings would favorably affect attitude, provide greater manoeuvrability during descent, and considerably increase the distance that could be covered laterally. Selective pressures would then favor larger and more manoeuvrable pro-wings and

shorter legs. The fossil record shows that wings of the oldest known insects (found at the base of Upper Carboniferous) are distinctly larger than those of the average modern insect; the legs are not noticeably shorter, except in some flying forms with large wings, such as some Palaeodictyoptera.

Special attention should be given to the resting position of the primitive wings. Early pterygotes, as summarized in this paper, were paleopterous. Hence, the first terrestrial adults had their wings spread out laterally, not postero-laterally as they are generally reconstructed. According to Neville ('65), the wings of modern soaring dragonflies are in elastic equilibrium and therefore are held in a horizontal position without effort. It is probable that this energy-saving type of flight was also present in early Paleoptera. Apparently the first flying Pterygota were able to soar effortlessly on their outspread wings and to switch to flapping flight at will in order to choose a landing site or to prolong flight (fig. 46B).

A comparative study of neuromuscular mechanisms shows that the wing beat in early flying pterygotes would have been much slower than in the majority of today's insects (Ewer, '63). Since thrust is related to the frequency of the wing beat, the resulting speed of flight was also bound to be low in these primitive and unspecialized forms. For aerodynamic considerations, slowly beating wings require a larger surface to obtain lift; the induced drag (caused by trailing and tip vortices) could have been substantially reduced by a lengthening of the wings (Neville, '65).

The fossil record shows that in the Paleozoic the ratio between the size of the wings and the body was conspicuously different than in modern insects and that the wings were relatively larger and longer (see Handlirsch, '06, for data on size). I assume that a combination of all the above mentioned aerodynamic factors caused the well known gigantism of Paleozoic insects, with their relatively oversized, long and broad wings.

Opposite selective pressures towards smaller insects with more manoeuvrable wings and greater concealment ability occurred later and has been pronounced since the Upper Permian. I suppose that a prerequisite for this tendency was the ability of a particular group to increase the frequency of the wing beat. A faster wing beat resulted from better coordination of the musculature, acceleration of

respiratory and muscular metabolism, improvement of muscle relaxation and neuromuscular mechanisms, and "automatization" of structures participating in flight. This ultimate evolutionary achievement helped to turn insect flight into the energetically most efficient muscular activity known. This was reached by storing elastic energy in cuticle, muscles, and rubbery ligaments of the wing hinge and releasing it again in automatically functioning and repetitive cycles (Neville, '65).

## II. *Origin and development of the alar circulatory system*

Blood circulates continuously in the wing pads of nymphs and in the membranous wings (as well as in sclerotized elytra or tegmina) of adults. Circulation transmits nutrients, water, and mechanical pressure, and plays a role in metabolism and perhaps also in respiration. It is necessary for physiological equilibrium, the normal development of sclerotization and pigmentation, and for the overall healthy condition of the wing in all stages of adult life. A cessation of circulation soon makes the wings brittle and results in a cracking away of "dry" parts (Arnold, '64).

According to Arnold ('64) blood is brought to the wings through alar blood sinuses via veins, cross venation, and reticulation (figs. 42-44). It is continuously leaking from some of the veins and to some extent probably percolates or diffuses between the basement membranes (fig. 41).

### *Circulatory system in modern and primitive wings of juveniles*

Veins are cuticularized, tubular continuations of the body haemocoel. They conduct blood, nerve fibres, and tracheae and give support to the wing. In the ontogenesis of modern Paleoptera and exopterygote Neoptera, the veins develop from free blood spaces, the lacunae, between the basement membranes (fig. 4: Cu + A, R + M, Sc, C). Lacunae, as far as is known, are not corrugated (Holdworth, '41; Woodring, '62), (figs. 3, 4). They are at first formed by epidermal cells only in the dorsal integument (fig. 4, Cu + A, DE). After being "shifted" into the wing pad, the lacunae are completed by the application of the epidermis of the ventral integument (fig. 4: VE) and they thus gain a mirror-symmetrical tubular profile (fig. 4: R + M, Sc, C). The pattern of the lacunae changes in each instar and only

towards the end of an ontogenetic line does it come to closely resemble the adult venation. Finally, the epidermal cells lining the lacunae secrete the cuticle which form the walls of the tubular veins. Only shortly before the emergence of the adult do the veins become formed and corrugated, and the epidermis degenerates. By then, the adult wing membrane and veins are almost completely composed of cuticle.

Consequently, modern nymphs have uncorrugated blood lacunae and the cuticular, corrugated venation is formed around them only in the final nymphal/adult moult. The "venation pattern" indicated on the wing pads of modern nymphs (fig. 29) are cuticular ridges which are *not connected with the blood lacunae* (compare figs. 3 and 4). However, they are rudiments of what once was the nymphal venation. Its repression and the postponement of the development of tubular veins above and under blood channels until the very end of the nymphal stage mostly occurred after the Paleozoic. It was independently acquired in all the then existing evolutionary lineages leading to modern insects. This fact has important implications for the interpretation of metamorphosis, as will be discussed in more detail later.

According to Tower ('03) and Bodenstern ('50), in the ontogenesis of modern Endopterygota the slowly growing wing evaginations underneath the larval cuticle have no distinct traces of future veins. In the prepupal instar the haemolymph is forced through the foramen of the wing and opens up visible lacunae (remnants of the wing cavity, vein anlage) between the two basement membranes. In the pupal instar these lacunae become more marked and their width is reduced. Before the emergence of the adult they become tubular. In newly emerged imagos the wings straighten through pressure of the fluid between the two epidermal layers and only after that do the wing veins harden.

In Paleozoic insects, the ontogenetic development of the circulatory system was quite different. The lacunae were already changed into cuticularized tubular veins in young nymphs (figs. 2, 6a-c, 22, 28, 30, 31, 35). Even the smallest nymphal wings were movable and articulated and were in need of being supported by the venation (Kukalova-Peck and Peck, '76). Therefore, the *sclerotized and cuticularized veins primitively are not solely adult structures*.

*Evolutionary changes in blood flow*

In modern insects, the blood generally flows from the thoracic perivisceral sinus into the anterior sinus, an area below the axillaries which is merely an extension of the haemocoel (fig. 41) (see Chapman, '69, for references). From there, the haemolymph usually enters the remigial wing circulation through the separate or fused blood sinuses of the respective veins. These sinuses at the veinal bases are sclerotized and form basivenal sclerites (also called alar pteralia) which are designated by the names of the veins: basicostale, basisub-costale, basiradiale, basimediale, basicubitale, and basianale (figs. 45A,B: C, Sc, R, M, Cu, A). The blood enters the wing usually only through the anteriorly located sinuses and flows distally to the wing apex through the large anterior veins, C, Sc, R, and in some cases M and Cu, and moves through cross veins towards the posterior margin. From there it returns through the posterior part of the circumambient C, usually via Cu and A into the body, by way of the axillary cord (fig. 44). After passing the cord (figs. 42, 43), the blood empties into the pericardial sinus or into the dorsal vessel.

The physical prerequisite for the steady loop-like transport of haemolymph is the so-called circulatory gradient. While the clustered axillary sclerites hold the membranes partially open to the flow of blood into the anterior veins, access into the posterior veins is closed by a sealing of the posterior articular membrane (fig. 41: black area). The only exit for a blood stream leaving the wing is the axillary cord. These adaptations create the gradient and force the blood to flow around in a single loop (Arnold, '64).

In the wings of primitive pterygotes (fig. 45) this modern sort of circumambient blood circuit was not possible for the following reasons: the costa did not encircle the wing but ended at the apex (and could not provide a posterior passage); the axillary cord, which is the main exit for the efferent blood stream in modern insects, was not developed; the basivenales (blood sinuses) were all widely opened, serial, and extended across the whole wing base (fig. 45A: C, Sc, R, M, Cu, A); and the axillary sclerites and tegula were also serially arranged, and provided uniform access to the flow of haemolymph (fig. 45A: t, 1, 2, m). Consequently, a circulatory gradient never occurred and all veins were equally opened and

accessible to the blood stream entering the wings from the body. Because blood could not circulate through the primitive wing, it in all probability pulsed in and out through parallel veins. The blood entered the wing through six wide blood sinuses (C, Sc, R, M, Cu, A of figs. 45A,B), and exited through the same basivenal openings.

In search for a possible retention of this primitive circulation in modern insects, I found that blood flow, according to Arnold ('64), is generally somewhat variable in all insect orders. Smaller accessory loops and local individual variations in circulation are quite frequent and the entire direction of flow can be reversed for periods of time. Likewise, individual veins, like M and Cu in Orthoptera and some other orders, can have a 2-way flow rather than a flow in predominantly one direction. In mayflies, the general loop-like blood flow, which is similar to that in all other modern orders, often alternates with an intermittent refluxing of blood into and out of the wing. This exceptional phenomenon has been attributed to the broad basal sinus and the pliable nature of the body wall, or to inefficient pulsatile organs (Arnold, '64). However, with the new data now available in the fossil record, a more probable explanation of this particular refluxing seems to be a plesiomorphic reflection of the primitive type of circulation through the serial veinal systems.

The blood sinuses at the base of the wings are as responsible for the origin of flight as are the veins. When sclerotized, they form the alar part of the primary hinge. Another blood sinus which occasionally participates in flight mechanics is the pterostigma (pigmented spot at the distal anterior wing margin). The role of the pterostigma is probably mostly physiological (Arnold, '63). However, in the dragonfly wing, the pitching moment of the pterostigma prevents torsional deformation of the corrugated surface during flight acceleration (Rees, '75).

The blood stream is kept in motion by different means, but mainly by aspiration through thoracic pulsating organs (see Chapman, '69, for references). They consist of a muscular plate which encloses a blood space beneath the dorsal wall of the thorax, often in the scutellum; in some insects the dorsal vessel may itself loop up to the dorsal surface to aspirate blood, in which case the muscular plate is beneath the scutum. Special pulsatile membranes also occur in the veins of some in-

sects and either conduct the blood centripetally or centrifugally. It seems possible that the scutellar pulsatile organ was present in the highly domed scutellum (sct in fig. 45A) of primitive homiopterid Palaeodictyoptera. Some other accessory thoracic pulsatile organs and/or veinal pulsatile membranes were almost certainly engaged in supplying blood to the six pairs of veins in the primitive wing circulatory system.

### III. *Origin of wing articulation*

The origin of alar pteralia has not until now been understood. Entomologists have made several assumptions: that at least some axillaries are actually extended veinal bases (Matsuda, '70; and for references: Hamilton, '71-'72); that the tegula is not serially homologous with the axillaries; that the detached third axillary, responsible for wing flexing in Neoptera, has its detached equivalent in Paleoptera; that the proximal median plate in Neoptera is of uncertain origin and does not occur in the Paleoptera; and that the so-called "axillary plate" at the base of the wings of Ephemeroptera and Odonata cannot be compared with any structure in the Neoptera. A unifying concept on the origin and homologization of pteralia has never before been offered.

A phylogenetic evaluation of ancestral pteralia suggests an obvious way for unraveling the riddle. Since Neoptera are believed to have evolved from Paleoptera through the acquisition of a flexing mechanism in the wing articulation (Carpenter, '71), the arrangement of very primitive pteralia in fossil Paleoptera might well provide the needed clues. Since modern paleopteran and neopteran pteralia are difficult to compare, they would possibly be more easily comparable with what is close to the common ancestral form.

With this in mind, I have searched the available fossils of primitive Paleoptera (Palaeodictyoptera, Megasecoptera, Diaphanopteroidea) since 1960 for suitable sets of pteralia, but found them either incompletely preserved or too specialized. Then, in 1975, through the courtesy of Doctor E. S. Richardson, Jr. (Field Museum, Chicago), I received two thoraxes of gigantic Palaeodictyoptera from the very primitive family Homiopteridae (specimen No. PE 16138, metathorax and hind wing, Field Museum of Nat. Hist. in Chicago; and specimen No. 2, coll. J. C. Carr,

metathorax and subcoxa, University of Illinois in Urbana). Both specimens are probably related on the generic level and were found in the Upper Carboniferous deposits (Westphalian C-D) near Mazon Creek, Illinois, by Mr. and Mrs. Wolffe and Mr. J. C. Carr. Preservation of the pteralia is good because of the large size of the specimens. The set of pteralia is not complete in either specimen but each is complementary with the other, so that the full series can be reconstructed between the two of them without additional hypothesizing. In figure 45, based mainly on specimen No. PE 16138, the second axillary sclerite, prealare, suralare and tegula, have been reconstructed after specimen No. 2 (Carr coll.). The diagram of the thorax and adjacent wing base (fig. 45B) is a generalization of specimen No. PE 16138 and an attempt to homologize pteralia of modern Paleoptera and Neoptera with a simplified, primitive, paleopterous pattern. A detailed comparative study of the articular region in Paleozoic and Recent Odonata and Ephemeroptera, and a comparison between both orders, is currently in progress. Preliminary results helped to identify homologous pteralia but, because of the quantity of documentary material, they have to be published separately. The taxonomic and morphological study of the homiopterid thorax, wing, and pleuron will be treated in a separate article.

### *Interpretation of pteralia in primitive Palaeodictyoptera*

In the articular region of Palaeodictyoptera (Homiopteridae) (figs. 45A,B), the hinge line (h, wavy lines in fig. 45A) separates the tergal unit composed of tergal pteralia including tegula and axillary sclerites (t, 1, 2, n-m, 3) from the alar unit composed of alar pteralia including basivenales (C, Sc, R, M, Cu, A). Consequently, the primitive paleopterous hinge is a composite structure in which both units participate. In the formation of the tergal articular structures, the tergum probably became incised by fissures and was then divided into five lobes posterior to the prealar arm (PRA): the prealare (p), the suralare (s), the median lobe (me), the postmedian lobe (pm), and the posterior notal wing process (PNP). The lobes became slanted distally into the deep sulcus, here called the paranotal sulcus (pa, striped lines in fig. 45A). A series of tergal sclerites separated from the tips of the lobes and became slanted upwards, forming their side of the convex hinge line: the

tegula (t) separated from the prealare (p); the first axillary sclerite (1) from the suralare (s); the second axillary sclerite (2) from the median lobe (me); the median sclerite (m) with the small detached notal median sclerite (n) from the posterior median lobe (pm); the third axillary sclerite (3) and sometimes the fourth axillary sclerite (4) from the posterior notal wing process (PNP). In this way, a regular series of tergal sclerites originated, in pterygotes, by their detachment from five lateral tergal lobes. The sclerites were probably primitively manoeuvrable by tergo-pleural (axillary) muscles. Most of these muscles probably became reduced, with the exception of those to the second and third axillary, and some muscles of the lobes (mainly the prealare and PNP). The wing flexor in Neoptera is attached to the third axillary. In Recent Paleoptera, the third axillary is an inconspicuous sclerite at the end of PNP.

The five tergal lobes on the tergal side of the hinge meet the six sclerotized veinal bases (basivenales, blood sinuses) on the alar side of the hinge. The hinge itself is homologous to the part of the dorsum separating the tergum and the wing evagination early in ontogeny.

The hinge-line was primitively straight and mesally paralleled by the deep paranotal sulcus (pa). Primitive tergal sclerites are arranged in a straight and regular row. Primitive basivenales follow the pattern and also form a straight row with the exception of the basicostale (C), which protrudes slightly proximally.

Basivenales are cuticularized and sclerotized blood sinuses, through which blood circulated back and forth in the primitive wing (see section on evolution of blood circulation). From each basivenale two branches arise which in pre-flight wings were very probably fully independent: the convex anterior branch, and the concave posterior branch. Early in their evolution, the pairs of the branches of R, M, and Cu became fused into common basal stems, a condition which is probably primitive for flying wings. The full primitive venation pattern of Pterygota (fig. 45) consists of the following veins: costa anterior (C+), and costa posterior (C-, discernible as a separate vein only in most ancient fossil insects); subcoxa anterior (Sc+, costal brace of Ephemeroptera, humeral vein of some Neoptera if rising from basisubcostale); the humeral vein of other Neoptera starts directly from Sc and is an aerodynamically based sub-

costal branch or cross vein) and subcosta posterior (Sc-); radius anterior (RI+) and radius posterior (Rs-, sector radii); media anterior (MA+) and media posterior (MP-); cubitus anterior (CuA+) and cubitus posterior (CuP-); anal anterior (AA, known as 1A+, first anal vein) and anal posterior (AP, known as 2A-, second anal vein).

The venation presented schematically in figure 45 is actually the most primitive known condition (preserved in specimen No. PE 16138 and some other Palaeodictyoptera). Paleozoic Ephemeroptera, Odonata, Protodonata, Protorthoptera, Orthoptera and Blattodea have well preserved posterior costa (C-) and anterior subcosta (Sc+) (personal observation, to be discussed in a later account).

Later, this complete venation pattern underwent many modifications, especially in the anterior and posterior part of the wing. However, except for the obsolete costa posterior (which became fused with the costa anterior to give more support to the anterior margin), all other veins are present in more generalized modern Paleoptera, as well as Neoptera, and can be phylogenetically identified and homologized. A detailed account of the complete scheme of wing venation and its application to the venation of modern pterygote orders will be presented in a later paper. A likely explanation for the origin of the unpaired mid-dorsal apodemal pits of the modern odonatan thorax is suggested in the migration of apodemal pits (ap in fig. 45A), which in Palaeodictyoptera are located mesally to each median lobe. In the ancestors of the Odonata, the apodemal pits of the two sides of the body migrated mesally and anteriorly and finally became fused into a single, apodemal pit in mid-dorsal position. The second axillary, which presumably detached from the median lobe, articulates with the first axillary and median sclerite in Ephemeroptera and Neoptera; in Odonata, it became fused with the first axillary and with the basivenal plate (Neville, '60). The postmedian lobe (pm) is rudimentary in modern insects but its respective detached sclerite, the median sclerite, is well represented in Paleoptera as well as in Neoptera; in Ephemeroptera, it was misinterpreted as the third axillary (Matsuda, '56, '70; Tsui and Peters, '72); in Odonata it was erroneously defined as the third axillary by Hamilton ('71-'72); the small notal median sclerite (n), apparently separated from the proximal part of the median

sclerite (m), has been detected in the Palaeodictyoptera. In Neoptera, the median sclerite is identical with the so-called "proximal median plate" of Snodgrass ('35), which was misinterpreted as a flange of the third axillary (Snodgrass, '52; Hamilton, '71-'72). The so-called "distal median plate" of Snodgrass ('35) is composed of alar veinal bases and corresponds usually to the basimedialcubitale. The posterior notal wing process (PNP) is present in both Paleoptera and Neoptera, and the third axillary sclerite is formed from its tip (as indicated in Recent Paleoptera). In Paleoptera, the third axillary is usually separated from the PNP by a suture and is only slightly detached at most; in Neoptera, it is distinctly detached and rotated, so that it can pivot about its point of articulation with the PNP and pull the wings into the flexed position. This ability of the third axillary sclerite, together with the consequent V-shaped arrangement of all tergal sclerites and with the basal fold running through the hinge-line, are the principle apomorphic (key) characters of Neoptera. In Hymenoptera and Orthoptera there is a fourth axillary sclerite, also detached from the PNP.

The alar side of the hinge is formed by sclerotized basivenales (veinal bases). In Recent Paleoptera, the basivenales posterior to the basicostale (humeral plate) increased in size and fused together into a large basivenal plate (axillary plate of Snodgrass, '35). The basicostale (humeral plate, humeral complex) in both Paleozoic Odonata and Ephemeroptera (unpublished material) is much enlarged; according to Neville ('60) the musculature vital for an odonatoid type of flight is attached to the enlarged basicostale. In Recent Ephemeroptera, however, the basicostale has degenerated to an inconspicuous plate. The basivenal plate in Odonata is formed by all basivenales posterior to the basicostale and by the first and second axillary sclerite, all fused together into one plate. In Ephemeroptera, the basivenal plate is formed only by a basisubcostale, basiradiale and basimediale, and is followed by the large, triangular basicubitale (misinterpreted as third axillary sclerite by Brodskii, '74) and by a small basianale (Kukalova-Peck, '74b).

In Neoptera, the basivenales are never large and do not fuse to such an extent. The basicostale (humeral plate) is inconspicuous, the basisubcostale rarely fuses with the basiradiale, the basiradiale sometimes fuses

with the basimediale, and the basimediale frequently fuses with the basicubitale (to form the so-called "distal median plate"). The anterior portion of the basianale, at which 1A + starts, has the tendency to become detached and migrate towards the basicubitale, with which it might eventually fuse. This phenomenon is aerodynamically based and associated with the formation of the claval furrow in the clavus, which is one of the principal supporting, deformation-limiting areas of insect wings (Wootton, '76: Int. Congr. of Entomology). This migration somewhat obscures the identity of 1A, so that it was given other names by some authors (postcubitus by Snodgrass, '35; Wallace and Fox, '75); third plical vein by Forbes, '43; empusal vein by Hamilton, '71-'72). Phylogenetically, this vein is the first anal (1A), the convex branch of the primitive anal veinal pair. The second anal (2A) was primitively concave and, in Recent insects, it became more or less flattened and forms the anal fan. Both anal branches 1A and 2A are homologous in all winged insects. In the phylogenetic sense, there is no 3A, 4A, etc. which authors have frequently described, because these are merely the (detached) branches of 2A.

In ancient Palaeodictyoptera, the thoracic tergal lateral lobes are better indicated than in any modern insects (fig. 45A). The sequence of the tergal axillary sclerites, and their detachment from the respective lobes, is quite clearly shown by their position. Their identity is obvious, because their arrangement is simple and serial; therefore, they can be fairly easily homologized with the pteralia of modern Paleoptera and Neoptera. In the alar part of the hinge, the basivenales are widely opened towards the body cavity and arranged so that they extend across the entire wing-base. This position is very suggestive of their role in primitive blood circulation and articulation, as previously mentioned. All these facts are extremely helpful in understanding the pterygote articular region and in providing evidence for its monophyletic origin.

My search in Paleozoic fossil material for ventrally located sclerites (epipleurites), the basalare and the subalare, to which the direct flight muscles (subcoxo-coxal muscles, etc.) attach and which are therefore the most important for the origin of flight, has so far been fruitless. Specialists generally agree that the basalare and subalare became detached from the dorsal part of the subcoxa

(pleuron) immediately under the base of the wing. The subcoxa, pleural suture, katepauran ring, anapleuran ring and trochantin are, to my knowledge, all preserved in only one specimen of a primitive Paleozoic paleopteran (in Palaeodictyoptera, Homiopteridae, from Mazon Creek, Illinois) and this will be described in another publication.

The above concept of the tergal origin of all axillary sclerites and the tegula finds support in the ontogenetic studies of Neoptera-Polyneoptera by Bocharova-Messner ('68). In her paper it was shown that the musculature associated with the axillary sclerites is, by its origin, definitely tergo-pleural. The primary role of tergo-pleural muscles was to strengthen and support the shape of the segments before the skeleton became sufficiently sclerotized. The pleuro-sternal musculature, namely basalar and subalar muscles, had the same primary destination. In modern weakly sclerotized Polyneoptera, such as roaches, these muscles are still bifunctional and at least partly continue to support the skeleton. In more tagmatized Polyneoptera with firmer skeleton, such as grasshoppers, this musculature assumes mostly the role of alar locomotory organs. Thus, the ontogenetic study shows that the axillary sclerites and tegula are primarily supported by a tergo-pleural set of muscles, while the basalar and the subalar sclerites, which presumably separated from the subcoxa, are served by pleuro-sternal muscles. This finding is in accord with the origin of pteralia as it is indicated by fossil record.

#### IV. *Wings and metamorphosis*

##### *Primitive position of wings in nymphs*

As explained by Bradley ('42) and others, only the meso- and metathoracic wings are in a mechanically suitable position to function in flight. Hence, the prothoracic wings of the primitive complete series gradually became reduced or engaged in other functions (leg- and head protection), and abdominal wings vanished with the exception of those in mayfly nymphs, in which they still aid in locomotion. The discussion in the following text is concerned with the meso- and metathoracic wings that are referred to only as "wings."

There is at present no agreement on the question of the primitive position of the wings in the pterygotes. The disputed points are: (1) Which condition was more primitive: wings oriented laterally or wings oriented obliquely-

backwards? (2) Why are the wings of all modern nymphs, both paleopteran and neopteran, oriented obliquely backwards, and how does this relate to the primitive pterygote wing position?

Before discussing these questions with the help of fossil evidence, it would be useful to point out some mechanical laws which, in Paleozoic pterygote nymphs, have affected the movement of wings of different sizes, while they were still functional nymphal structures.

In an aerial environment, a small wing is restrained by aerodynamic laws and unfitted for active flight. In an aquatic environment, a small wing may prove to be comparatively much more useful for propelling the animal forward. But, other things like legs, tails, body movement, or anal water jets, can serve as more powerful swimming tools, as demonstrated in modern aquatic beetles, waterbugs, mayflies and dragonflies. Therefore, in both environments, small wings were comparatively inefficient devices for forward movement.

If the small wings extended laterally, they would impede the nymph's forward movement among vegetation on dry land as well as in water. It is thus a matter of survival for both terrestrial and aquatic nymphs to keep their small wings from hindering their motion.

On the other hand, as soon as they were large enough to serve in flight, wings were extremely useful for dispersal, migration, mating and escape, and their value for survival increased in linear relationship to maturity, reaching a peak in the adults. The resulting evolutionary trend would therefore be 2-fold: to keep small wings out of the way by streamlining young nymphs, and to deliver wings in full size and undamaged condition to the adult stage, where they are most useful.

In the course of evolution, this adaptive problem was solved in two sequential phases. During the first phase, which is well documented in the fossil record, the wings of the nymphs remained articulated and movable but became streamlined (fig. 46:a, a', b). In the paleopteran orders of the Pterygota (fig. 46:a, a') this task was accomplished either by development of the so-called "*nymphal wing bend*" (the curvature in the basal third of the wing which turned the tips obliquely backwards as in fig. 46:a), or by *flexing the wings backwards* over the abdomen (in the extinct order Diaphanopteroidea) by a different mech-



anism than in Neoptera (fig. 46:a'). In the earliest Neoptera (fig. 46:b) the same problem of streamlining was solved by flexing the wings backwards with the help of the pivoting third axillary sclerite. This evolutionary advancement eventually became the key character of the Neoptera. It is believed here that the wing-flexure occurred first in the immatures, but it proved to be very advantageous for the adults as well. Thus, the evolution of wing flexing is viewed as having started as an adaptation for better streamlining in the juveniles.

During the second phase, (fig. 4, Recent), the pre-adult wings in both Paleoptera and Neoptera became completely immobilized and streamlined in a protected position. This was achieved in two different ways: (1) In Paleoptera (fig. 46:a, Recent) and in exopterygote Neoptera (fig. 46:b, Recent) the wings were fixed and fused mesally with the terga, and the wing integument was thickened. The cuticular, tubular venation ceased to be useful and became vestigial, so that only traces of former veins occur as weak cuticular ridges on the wing pads of modern nymphs (fig. 29). The blood lacunae representing the venation were submerged deeper into the pad, so that they became well protected on both sides by the epidermis (fig. 4). The surface of the wing pads was reinforced by cuticular rugosities, hairs, and tubercles. (2) In endopterygote Neoptera (fig. 46:b', Recent) the immobilization and protection of juvenile wings was achieved by their reduction to imaginal discs. These are simple formative centers of small cells which appear as epidermal thickenings. Imaginal discs of wings and other adult organs became invaginated under the larval cuticle and their development during the larval stage was substantially slowed down. They are recovered in full adult size during the prepupal and pupal instars chiefly by cell multiplication (Bodenstein, '50). Invagination of extremely suppressed juvenile wings was the key character which gave a monophyletic start to a new successful neopteran group, the Endopterygota. As proposed by Adams ('58), there is a relationship between these and the plecopteroid line. It can be found in wing venation (figs. 9A,B), setation, and in the presence of the furcasternum and of the sternal articulation of the coxae. Here it is believed that endopterygotes were derived from some unknown family of plecopteroid Protorthoptera which

had not yet developed an expanded anal fan in the hind wing, which had richly branched venation, and whose macrotrichia were scattered on the wing membrane. From the available fossil record, I consider members of the family Strephocladidae (their "endopterygote" features have been pointed out by Carpenter, '66) to be rather close to these hypothetical ancestors.

As discussed and documented in more detail by Sharov ('57a, '66) the ancestral stock of plecopteroid Protorthoptera, as far as is known, had articulated nymphal wings (a well preserved forewing *not fused with the tergum* is shown on fig. 48). In one paper Sharov ('57a) described a continuous ontogenetic series of nymphs and subimago-like nymphs showing that their development lacked the metamorphic instar. With the probable ancestors being definitely ametabolous, the Endopterygota developed their "complete" metamorphosis directly from the very primitive and confluent series of plecopteroid immatures which had freely movable wings and lacked metamorphosis.

The postero-lateral orientation of nymphal wing pads in both Paleoptera and exopterygote Neoptera occurred independently and in parallel. First, the wings were independently streamlined and directed backwards in both groups, but by different means: one by a "nymphal wing bend" (figs. 6, 31), the other by a pivoting third axillary (fig. 35). Then, they were immobilized in this streamlined position (fig. 46:a, b, Recent). Hence, in spite of their notably similar outward appearance, the paleopteran and neopteran nymphs of today are as phylogenetically different as are the adults.

Fossil evidence provides an answer to the second question posed at the beginning of this section: the postero-lateral position of the wing pads in modern insects is secondary and is not homologous in Paleoptera and Neoptera. The ontogenetic stages of Pterygota have followed a different alar evolutionary pattern than the adults, because they have been exposed to different survival problems and different selective pressures (fig. 46A,B, upper half compared to lower half).

#### *Primitive position of wings in adults*

The phylogenetically primitive position of adult wings at rest in early Pterygota is still a matter of dispute. A popular hypothesis of

Bekker ('52), developed by Sharov ('66), Wootton ('76) and Rasnitsin ('76, '77) suggests that the oblique-posterior position of the wings is primitive and that it echoes the orientation of "paranota" in the hypothetical first "gliding" Pterygota. Paoliidae, the first recorded pterygotes whose wings at rest are oriented obliquely-posteriorly, were referred by Sharov ('66) to a separate cohort "Protoptera," which I think has no basis in reality. Protoptera supposedly represent the most primitive pterygote group with a flying capability, from which both paleopterous and neopterous conditions developed. In Paleoptera, the wings "lost" the ability to draw back and became constantly spread out at the sides; in Neoptera, the wings gained the ability to flex completely backwards over the body.

There is no serious doubt that Paoliidae are extremely primitive in having nearly homonomous wings with small, completely unfoldable anal areas. However, their venation carries all neopterous features discussed in the first section of this paper. The question is this: is the *position* of flexed wings to be considered phylogenetically as more important than the *fact itself of flexing*? First of all, the postero-lateral "paoliid" position seems to be quite common in families in the primitive Paleozoic order Protorthoptera, in which the neopterous nature has never been questioned. Only the *angle* of the flexed wings is variable but the wing-tips are often not overlapping but pointing postero-laterally. Resting Protorthoptera are even reconstructed this way by Sharov himself (fig. 33). Other "paoliid" orientations of wings have been gained secondarily in advanced insect groups like flies, some moths and some caddis flies. The position of the resting wings varies; e.g., in moths, on a subordinal level, from roof-like to oblique posterior and even to overlapping. The only difference in the wing position between ancient Paoliidae and modern Megaloptera is that in Megaloptera a very small part of the anal area (proximally from 2A) is folded under the wings, while in Paoliidae it is not. Other than that, both groups have equally shaped wings with small anal areas, and their alar angle is the same. Clearly, the angle of the wings at rest does not rank highly in phylogenetic significance and is correlated mainly with the wing-shape and with the quality of the anal area (rigidity, size, foldability, etc.). Therefore, the particular position of the wings at rest is seen here to be sequential and sec-

ondary to the fact of flexing itself and belongs to a lower phylogenetic category.

It should be noted, however, that the almost homonomous character of the wings and the unfoldable anal area, as they occur in Paoliidae, are definitely primitive characteristics for the Neoptera as such, and they are demonstrated in the fossil record. They have been inherited by Paoliidae from the immediate ancestors of Neoptera, the early Paleoptera, and were carried over almost unchanged to primitive living Endopterygota (i.e., Megaloptera). This fact is viewed as valuable evidence that the endopterygotes are derivatives from an early neopteran stock. Thus, the postero-laterally oriented wings of the earliest known Neoptera (Paoliidae) and several other families of Protorthoptera are seen as documenting the opposite of what Sharov ('66) and others believed: they represent the early stage in the development of neoptery from the more primitive, ancestral paleoptery.

According to Rasnitsin ('76), palaeodictyopteran and all early pterygote nymphs could probably "flex" their wings backwards; he regarded this as a primitive feature. This assumption is not supported by the arrangement of pteralia in the primitive palaeodictyopteran hinge, which lacks both a basal fold and third axillary sclerite in the pivoting position (figs. 6a-c, 45A,B).

The concept of a primitive, oblique-posterior position for the wings in early Pterygota is attractive to the supporters of the paranotal theory and to the seekers of a straight-forward explanation of nymphal wing pad orientation in Recent insects. As documented in this paper, however, this reasoning is based only upon an outward resemblance, and this is foreign to phylogenetic thinking and does not find any support in the fossil record. The arrangement of the sclerites in the newly described primitive articular region of ancient Paleoptera (fig. 45A), with two simple, parallel rows of pteralia lined up along the straight hinge, clearly indicates that the simplest possible wing-articulation was paleopterous. As observed in Recent Paleoptera, the third axillary is a small sclerite divided from PNP only by a suture (fig. 45B). The neopterous V-shaped arrangement of pteralia is much more sophisticated; it can easily be derived from the primitive paleopterous hinge by shifting the third axillary into the pivoting position. A reverse direction of development, or even the attempt to derive both arrangements from

some kind of intermediate ancestral type of articulation, as proposed by Sharov ('66) and Wootton ('76), is unrealistic. The problem will be discussed and documented in more detail in a subsequent publication.

Clues to the phylogenetically primitive position of pterygote wings are also available in the morphology of living insects. It is recapitulated in the earliest wing development of generalized modern insects as described by Tower ('03), Dürken ('23), and Bocharova-Messner ('59, '65). In fact, *all* nymphal wings in Pterygota, in Paleoptera as well as Neoptera, are at first oriented laterally, i.e., in the primary, paleopterous position (fig. 36). This circumstance quite likely reflects the paleopterous character of early Pterygota. The explanation as to why the small wings in the young nymphs would recapitulate the actual phylogeny while the larger wings in older nymphs do not, is seen to be quite simple: immediately after evagination and during their migration towards the tergum, the wing buds (fig. 36) are too small to interfere with movement or any other activity. Therefore, no adaptive trend (other than a merging of the number of instars) alters their natural phylogenetic position.

The generally more primitive nature of Paleoptera is also reflected in the well known fact that Paleoptera share numerous characters with Apterygota which they do not share with Neoptera, and which Neoptera do not share with Apterygota (Snodgrass, '35).

#### *Onset of metamorphosis*

All Recent pterygotes are subject to metamorphosis (defined as given in the INTRODUCTION) which evolved as a consequence of the immobilization and suppression of nymphal wings. Metamorphosis compensates for all secondary changes in wing size, venation, and articulation which mainly occurred during Postpaleozoic ontogenetic development. In the Paleozoic, nymphal wings of all ancestral insect groups were primitively articulated (not fused) to the tergum, had tubular venation and were functional. Their size increased gradually at each ecdysis until the adult size was reached (metamorphosis was not yet necessary). This condition has been found in several families of fossil Ephemeroptera (Kukalova, '68), Megasecoptera (Carpenter and Richardson, '68; Kukalova-Peck, '75; and undescribed material), Palaeodictyoptera (Wootton, '72; Sharov, '66, '71a,b; Kukalova-

Peck and Peck, '76), Protorthoptera (Sharov, '57a, '66) (figs. 48,49; and undescribed material), and Miomoptera (Sharov, '57b). The number of instars was probably greater than in any group of modern insects and development was characterized by a slow and sequential increase in wing size (Sharov, '57a). The change of "younger" instars into "older" instars and of those into "imaginal" instars was confluent (Kukalova-Peck and Peck, '76; and undescribed material), (fig. 6, 30) and it is quite likely that moulting continued even after the insects reached maturity, as in living Apterygota (Sharov, '57a).

How does this evidence of ametaboly, found in several lines of Paleozoic pterygotes, relate to the probability of the multiple origins of metamorphosis? In phylogenetic terms metamorphosis is defined as a restoration to the adult of features that selection has suppressed in the immature (Wigglesworth, '50) (namely the retarded structural growth of wings, the suppressed wing articulation, the abolished venation, etc.). One (in Paleoptera and exopterygote Neoptera) or two (in Endopterygota) metamorphic instars bring all these structures back into working condition. Since the fossil evidence records that all known Paleozoic Ephemeroptera were ametabolous, whereas all of today's mayflies are metabolous and have the metamorphic instar, the ability to metamorphose could not have been inherited from the ancestor, but was instead gained in mayflies in the time period between the Paleozoic and the Quaternary. A similar type of simple deduction can be applied to other evolutionary lineages, i.e., to Odonata (in spite of the fact that fossil immatures have not yet been found), under the premise that Odonata, as well as Ephemeroptera, Palaeodictyoptera, Megasecoptera and Diaphanopteroidea, descended from a common paleopterous ancestral stock. The fossil evidence shows that Paleozoic Ephemeroptera, Palaeodictyoptera and Megasecoptera lacked metamorphosis, a condition which is generally considered to be primitive for Insecta. Hence, the ancestral stock was *primitively ametabolous*. To assume that early Odonata developed from these ametabolous ancestors means also to assume that the metamorphic instar of Recent Odonata is apomorphic and must have *originated between the Upper Carboniferous and the Quaternary*. The mutual relationship of metamorphosis in modern Ephemeroptera

and Odonata, consequently, is that of parallel evolution. It is here proposed (and it will be discussed in more detail in a separate publication) that metamorphosis in pterygotes originated independently and several times: at least twice in Recent Paleoptera, at least four times in exopterygote Neoptera, and only once in Endopterygota (fig. 46: A, a, b, b', U. Paleozoic-Recent).

The origin of the Endopterygota was the last major event in the macroevolution of the grades of Pterygota. However, as shown above, it happened very early (in the Lower Carboniferous?) probably even before the beginning of the known record of the first flying insects. The presumption that the Endopterygota stemmed from very ancient Neoptera is also supported by their inheritance of some early neopteran characters, such as: two homonomous pairs of wings with similar venation; the presence of the subcoxa anterior (Sc+), MA, and branched CuP; the presence of serial larval abdominal legs (tracheopods); 5-segmented tarsi; etc. Since the supposed ancestral stock of plecopteroid Protorthoptera in the Paleozoic is repeatedly recorded to be ametabolous (Sharov, '57a, '66), the so-called "complete" metamorphosis of Endopterygota probably developed from ancestors which *lacked* the metamorphic instar. This hypothesis might be substantiated, or at least reflected, in experiments on hormonal action in Recent insects. The conclusion that holometabolously developed from an ametabolous condition, was previously reached by Sharov ('57a).

According to Tower ('03), Bradley ('42), Bodenstern ('50), Imms ('64), and Chapman ('69), in the ontogenetic development of modern Endopterygota the wings start as epidermal thickenings which frequently are already evident in the embryo. In the primitive type, a considerable area of the epidermis draws away from the cuticle after hatching; then the dorsal portion of the tissue thickens and is evaginated outwards into the space between the epidermis and the cuticle. A similar process occurs in more specialized types, in which the wing might evaginate inside of pocket-like peripodial cavities. In the larval stage the wings grow slowly; in the prepupal stage, when the larva ceases feeding, the wings increase rapidly in size due to a rearrangement of epithelial cells and pumped-in haemolymph. The blood pressure finally pushes the wings out and downwards from the cavity. The wings grow very rapidly while

changing form, and before pupation assume the definite position of the pupal wings. The pushing of the wings out from the cavity is often erroneously paralleled with the primary eversion of the wing sack in Paleoptera and exopterygote Neoptera.

The ontogenetic development of modern Endopterygota is here considered to be parallel with that of Paleoptera and exopterygote Neoptera. Two different events are recognized: (1) The eversion of the wing-sack *under* the endopterygote larval cuticle parallels the external eversion of the wing buds in the early instars of all other insects. This reflects a major phylogenetic event, the very origin of the wings and therefore also the origin of the Pterygota, which happened some time in the Upper Silurian or Lower Devonian. (2) The passing of the wing outward from the body in the prepupal instar *does not have a parallel* in the other insects. It is part of a phylogenetic event which was peculiar to Endopterygota: the invagination, subcuticular development, and again evagination of larval wings. This marks the origin of the Endopterygota, and it happened much later, sometime in the Paleozoic.

A physiologist might find this new fossil-based concept of multiple metamorphosis more suitable for an interpretation of his experimental data. In the following text an attempt is made to interpret the metamorphic instar in the light of the fossil evidence. Metamorphosis of parts other than wings is omitted because, in a phylogenetic sense, they are lower in a ranking of character importance and their changes were subsequent to changes in the wings, which are the key character.

Ontogeny of early Pterygota was ametabolous and the growth of nymphal wings in the whole series of instars was completely sequential. Therefore, the metamorphic instar was not needed. It is believed here that this type of development occurred in all ancestors of the main modern lineages: Ephemeroptera, Odonata, hemipteroids, orthopteroids, blattoids, plecopteroids, and Endopterygota. However, as discussed previously, selective pressures on pterygote nymphs led to a *suppression* of the size and movability of nymphal wings (fig. 46:A- Recent), while in adults it *emphasized* the larger size of the wings and the capacity to fly (fig. 46:B- U. Paleozoic, Recent). Eventually the breaking point was reached, at which metamorphosis became inevitable. This breaking point is believed to

have occurred among the series of *subimaginal instars* (figs. 6e,d, fig. 30: last instar; Kukalova-Peck and Peck: fig. 4; and undescribed material); their intermediately-sized wings made them vulnerable to selective pressures because they were less capable of flying than adults and also less capable of concealing themselves among vegetation or in crevices than younger juveniles. Finally the primitive sequential ontogenetic series became disconnected at this weak link and an (unknown) series of older nymphs were compressed into one (or two in the case of Endopterygota) metamorphic instars. On the basis of the fossil record it is not evident how many subimaginal instars became incorporated with the imaginal stage, or were compressed into the metamorphic instar, or were coalesced with the larval stage. In modern Ephemeroptera, the last (?) subimaginal instar (the subimago) has persisted to Recent times as a living fossil and the metamorphic instar was formed from an unknown number of previous older instars. This fact seems to support the above interpretation of metamorphosis. If the ontogeny of the ancestral stocks of all modern lineages was primitively ametabolous, then the formation of the metamorphic instars must have occurred separately and independently in each line, a process which left room for much variety.

After the metamorphic instar was established, selective pressures towards further suppression of juvenile wings probably continued, and the changes in the metamorphic instar became genetically more firmly fixed. I cannot see, from a phylogenetic viewpoint, any substantial difference between metamorphosis in Endopterygota and the rest of the insects. It seems to me that there is a perfect parallel between all the phylogenetically important events concerning the key character—the wings. In Endopterygota, many imaginal structures originate in the embryo as epidermal thickenings and later invaginate so that they develop in the larval stage completely hidden under the cuticle (Bodenstein, '50). This process includes not only wings but also legs, the thorax, head structures, etc. However, subcuticular development of the wings is not peculiar to Endopterygota. As mentioned by Tower ('03) wing buds of some Orthoptera appear and then evaginate in the embryo under the cuticle and become external only after the first ecdysis. Many data supporting parallel ontogenetic development of

all pterygotes were recently summarized by Hinton ('76). Novák ('66) gave a summary of opinions opposite to Hinton's in which the endopterygote larva is frequently seen as a kind of living embryo and extensive des-embryonization and/or embryonization is postulated. From the macroevolutionary viewpoint, the derivation of a major and old group like Endopterygota was almost certainly caused by some change in the basic pterygote key character, *which is the wings*. If all three major living groups of Pterygota (Paleoptera, Neoptera Exopterygota, and Neoptera Endopterygota) are compared on the level of this primary character, all features are perfectly homologizable and the comparison of the events in their ontogeny can be made without difficulty. If other characters are employed in the same task, the homologization is difficult or impossible and so is the comparison of the events in the larval stages. (The Berleyse-Imms-Polyarkoff hypothesis views the oligopod, and pre- and post-oligopod larval stages as phylogenetically important; however, within just one order, the Coleoptera, the types of larvae vary from campodeiform to apodous, etc.).

A phylogenetic explanation for the well known fact that some Homoptera (whiteflies and male scale insects) have a quiescent and pupa-like last nymphal instar is thus not that there is close relationship between Hemiptera and Endopterygota, but that they *happen* to be convergently similar in their metamorphic instars. The only way to explain metamorphosis in modern insects, then, is by assuming its multiple and independent origin and parallel evolution in the major lineages. We can thus account for the many variable ways in which insects metamorphose.

Recent imago sometimes retain many nymphal features for diverse periods of time. This happens typically under conditions when the mode of life is "nymphal," i.e., secretive, in hiding spaces. Roaches are an example: in the Paleozoic, only fully winged adult forms of cockroaches are known in a rich record of tens of thousands of fossil specimens. On the other hand, many modern species become "nymphalized" in appearance by reduction or loss of their wings and are carrying over the nymphal wing musculature and other features into adulthood, as observed by Bocharova-Messner ('68). A similar process is known in other insects. In the cricket, *Acheta domestica*, as described by the same author, some nymphal

characters of the flight apparatus are carried over through the metamorphic instar into the imago; adult flight musculature is delayed in development and becomes functional only in the older adult. This and similar observations suggest that the *suppression of the flight apparatus is not restricted to the larval stage and is not impaired by the metamorphic instar*, but might occur whenever there is a "need" for a flightless condition. It also shows that life in secretive places might trigger an adaptation which, in all probability, was the primary cause of the origin of metamorphosis.

#### V. Principles of irreversibility and irrevocability of evolution

While discussing with various entomologists the results presented in this paper, I was cautioned that the articulated attachment of Paleozoic nymphal wings (presently known to exist in 5 primitive orders, including all known nymphs of Ephemeroptera and plecopteroid Neoptera) might not be a primitive, but rather a highly advanced condition. As an alternative, it has been repeatedly suggested to me that the wing pads of modern nymphs, which appear as continuous expansions of the terga, might be primitive "paranota" directly inherited from unrecorded (Devonian) ancestral lineages (i.e., that the mainstream of wing evolution might have bypassed the contradictory Paleozoic fossil groups). Another suggestion was that the articulation of the wings has even been "reversed" in modern nymphs back to the ancestral state of tergal paranota. Both these alternatives are completely alien to the basic concepts of phylogeny. First, the evolution of structures *does not consist of independent changes of organs or traits; what changes is the genetic system, and the developmental system rests on it* (Dobzhansky, '70; De Beer, '71; and others). I know of no case in the fossil record of the entire Animal Kingdom where a key structure temporarily occurred in ancient juveniles in a functional and perfected form, while modern juveniles are left with the ultra-primitive pre-adaptive condition of the same key structure. The above two interpretations of the fossil and Recent data are clearly against all the accumulated experience of paleontology as well as of genetics. On the other hand, it is a well known phenomenon that the simplification and reduction of complicated structures, if unnecessary or obstructive to an adaptive trend, are very common, *especially in*

*the juveniles*. Another common evolutionary trend is that juveniles often follow different adaptational patterns than adults and end up with distinctly different morphologies. For these reasons, the most acceptable explanation is that juvenile organs of flight became reduced and progressively more and more different from those of the adults because the juveniles did not need wings in their habitats and for their mode of life. This is consistent with the fossil record and with genetic principles in general. In consideration of the possibility of the reversibility of characters and structures, there is indeed a school that rejects the principle of irreversibility of evolution, as currently defined and favored by paleontologists and geneticists. This is based upon occasionally observed events in laboratory populations, such as the disappearing and reappearing of certain bristles in flies, halteres turning "back" into wings with veins, heteromorphosis in the regeneration and replacement of a lost antenna by a leg, or of halteres by legs, etc. The matter has been thoroughly examined by geneticists and their conclusion is that *genetics does not provide the key to the problem of homology*, as proven by frequent substitutions of non-homologous structures (production of an extra antenna instead of eye, etc.). De Beer ('71), in a discussion of these strange phenomena, takes the stand that homologous structures *need not be controlled by identical genes*, and notes that this highly important fact has been experimentally verified. It means that the homology of phenotypes does not imply similarity of genotypes. Hence, the same bristle of a fly may be controlled by different genes and its "reappearance" does not necessarily prove the reversibility of evolution, especially in the light of the massive and contradictory evidence accumulated in the past two centuries by paleontologists.

A good understanding of the "principle of irreversibility of evolution" is basically necessary for all phylogenetic considerations, including the correct interpretation of insect morphology. Its validity is viewed by geneticists as dependent on the micro- or macro-level of the evolutionary changes while the distinction between them is considered to be quantitative. The mutation (i.e., *microevolutionary* change) that is only temporarily favored by selection is generally believed to be reversible; the lost combination can be recovered by recombination or back mutation;

and the direction of selection may change in a different environment. By no means, however, does this alter the broader fact that as soon as a *macrostructure* is genetically established, *evolution does not double back on itself to return to ancestral states*. This fact is basic for evolutionary biology and is complemented by the important "principle of irrevocability of evolution," which is: *The influence of the ancestral condition is not fully lost in descendent groups*. In phylogenetically sound reconstructions of lineages, one should expect both principles to be expressed.

Applied to the particular case of nymphal wing articulation, the "principle of irrevocability" is evident in the following sequence of features: 1. The wing articulation arose only once (monophyletically) in the Pterygota, as documented by homologous articular sclerites within the whole taxon; 2. The articulation was lost separately and independently in most phylogenetic lines, as documented by the different times at which they were lost, shown by the fossil record; 3. The loss of the nymphal wing articulation was followed by the simultaneous and independent appearance of metamorphosis, as documented by fossil evidence. Thus, the articulation that ceased to be useful for the juveniles was suppressed, while the same articulation that was essential for the adult was again released during metamorphosis. Both processes are hormonally controlled and the manipulation of the condition of the wings and of the articular structures through hormonal action is a phylogenetically new (or younger) function for the already existing endocrine system.

The complementary "principle of irrevocability of evolution" in the wings of modern nymphs is clearly demonstrated by: 1. The remnants of a once functional venation remaining as cuticular ridges on the nymphal wing-pads; 2. The fact that the wing *anlagen* always evaginates above the spiracle; 3. The migration of the wing-buds dorsally towards the tergum; 4. The generally lateral (i.e., paleopterous) orientation of all young wing-buds; 5. The fusion of the wing-buds with the lateral margin of the tergum; 6. The preservation of the dual (i.e., tergal and alar) origin of sclerites forming the different sides of the hinge; 7. The preservation of the subimaginal instar in Ephemeroptera as witness to a previous and generally present incremental and ametabolous ontogenetic development; 8. The preservation of a reduced hinge in some wing-

derived prothoracic lobes; and 9. The preservation of residual wing venation and musculature in the wing-derived abdominal "gills" of Ephemeroptera.

These ancestral conditions which are expressed in wing morphology and development are neither abundant enough nor sufficiently understood to serve as a secure basis for a complete explanation of wing origin. However, any real reconstruction of this important event, as well as the correct interpretation of the morphological structures in modern insects, are bound to include an adequate and internally consistent explanation for all these interrelated features and phenomena.

#### VI. *Wings and taxonomy*

##### *Differential diagnosis of Paleoptera and Neoptera*

In the current entomological literature, there is a remarkable uncertainty about which characters reliably separate Paleoptera from Neoptera. This question has to be approached on a phylogenetic basis, by following the sequence in which the characters developed.

Paleoptera and Neoptera are sharply separated by three ancient characters: the presence or absence of wing flexing; the intensity and regularity of primitive vein corrugation; and the arrangement of the pteralia. Nevertheless, none of these features, as such, is directly diagnostic.

*Wing flexing.* The ability to flex the wings backwards over the abdomen at rest has developed twice, in Neoptera, and in one order of Paleoptera, the Diaphanopteroidea. There is a common misunderstanding about the phylogenetic significance and validity of this flexing for the separation of Paleoptera and Neoptera, based on casual observations of paleopterous Odonata, namely damselflies. They seem to show that they can flex their wings backwards over the abdomen, thus being "neopterous," and seem to give the lie to the reality of the paleopterous category. However, careful examination of damselflies reveals that the posteriorly directed position of their wings (while at rest) is achieved by a change in the nevertheless paleopterous thoracic construction. The thoracic segments are displaced from a vertical position to a nearly horizontal one, so that the wings become posteriorly directed. In this way the anterior margin of the wing at rest is placed dorsally and upwards with respect to the body, rather than being

pivoted and placed laterally and near the insect's ventral surface as in the neopterous condition. Thus, damselflies only lift their wings upwards in the same way as modern mayflies. This movement is simple and does not require any complicated mechanism, and is not convergent to neoptery. The neopterous sclerite mechanism is, in comparison, very complex and resulted from a more profound adaptational process.

Neoptera were derived from the ancestral paleopterous stock with short mouthparts at a very early period in insect evolution, by development of a wing-flexing ability through a pivoting of the third axillary sclerite. Their *basal fold for wing flexing is located directly within the hinge line*; the veinal corrugation in the central wing area (Rs, MA, MP, CuA) has become successively less distinct. Diaphanopteroidea (fig. 27) were derived later, directly from the extinct paleopterous order Palaeodictyoptera with elongate haustellate mouthparts, after the true neopterous lineage was established. They are stratigraphically younger than Neoptera (according to present fossil record). Their flexing mechanism is not known, but it must have been different from that of the Neoptera, since their wing-flexing *basal fold was located distal to the basivenales and not within the hinge*; the corrugation was not affected by wing-flexing and remained typically paleopterous (Kukalova-Peck, '74a).

*Corrugation.* The "typical" accentuated corrugation of Paleoptera tends to become lessened in some specialized Recent Ephemeroptera. According to Edmunds and Traver ('54) the corrugation in the radio-medial area is being suppressed in the Palingeniidae, Behingiidae, and Oligoneuriidae. This occurs by a migration of the concave veins to the vicinity of the convex veins, or by a near fusion of the concave veins with the convex veins (very weak concave veins lie next to the convex veins or in the fold beneath the convex veins). Oligoneuriidae have developed a sculling type of flight which is, according to these authors, responsible for the tendency to suppress the fluting. The "typical" condition of the centrally located veins in most modern Neoptera is flat (not corrugated) but is slightly corrugated in some primitive living Neoptera and in fossil Protorthoptera, and highly corrugated in specialized Recent Endopterygota.

It is thus clear that neither the presence or

absence of wing flexing nor the corrugation of central alar veins, but the particular character state of these features, as phylogenetically evaluated, securely separate the Paleoptera from the Neoptera. Similar modifications developed at least twice in each group, but by different means, thus giving a typical example of convergence. Therefore, the establishment of key characters between Paleoptera and Neoptera is somewhat difficult. I suggest that the position of the basal fold within the hinge (in Neoptera) or distal to the basivenales (in the convergent Paleoptera) can be used as a distinctive feature whenever there is a need to cover both extinct and extant orders.

*Pteralia.* For Recent Neoptera, the V-shaped arrangement of the tergal sclerites with the median sclerite and the third axillary sclerite forming the V-angle, and the presence of a pivoting third axillary, are the phylogenetically based and distinctive basic characters which are both apparent and simple. I do not recommend using this differentiation for the extinct orders, because we do not know whether or how the third axillary was engaged in flexing in the paleopterous Diaphanopteroidea. An unfailingly distinctive feature for the Recent Paleoptera is the extensive fusion of the basivenales into a large basivenal plate (sometimes called the "axillary plate" in Paleoptera, or "radioanal plate" in Odonata, and "median plate" or "subcostomedian plate" in Ephemeroptera); the size of basivenales in Neoptera is always comparatively negligible. Another feature of the Paleoptera is the position of the median sclerite; this is always located posterior, or postero-proximal to the second axillary sclerite, but is never distal or postero-distal to it, as in the Neoptera.

#### *Monophyly and parallel development in Pterygota*

As generally accepted by paleontologists and pointed out by Hennig ('66), the main contribution of the fossil record to recent classification is that it makes more possible the correct classification of the categories of resemblance between characters, by revealing convergence and symplesiomorphy. The phylogenetic system classifies organisms according to their degree of phylogenetic relationship. In this system, the possession of at least *one derivative ground-plan character* (basic apomorphic character) is a precondition for a group to be recognized as a monophyletic



group. All available fossil evidence testifies that the basic apomorphic character (the key character of Mayr, '63) for Pterygota is the presence of wings. These induced the origin of Pterygota, but also the origin of Neoptera, and Endopterygota, in three subsequent steps of wing evolution.

Here, I propose that all major evolutionary steps with respect to wing development happened *not in the adult, but in the juvenile stage*, as follows: 1. Pterygota originated monophyletically from a common ancestor of both Archaeognatha (including Monura) and Thysanura, through the origin of a paleopterous type of wings; 2. Neoptera originated monophyletically from the early Paleoptera through the development of wing flexing by a pivoting third axillary sclerite; and 3. Endopterygota originated monophyletically from the generalized plecopteroid-type of Proorthoptera, through the withdrawal of developing wing buds into subcuticular pockets. In the first and second step, the innovation in juvenile wing characters was carried on to the adults. All three steps had tremendous impact on the radiation, dispersal, survival, and distribution of the particular new group (fig. 46). The other characters, which became diversified before or after each major event, followed various mosaic and parallel patterns. Hence, the accompanying characters, like the state of the anterior mandibular articulation, are not decisive in judging the phylogenetic category of the three major respective groups (but may be helpful as being indicative of it).

The following wing characters, sometimes previously regarded as important for classification, have been documented by fossil evidence to be parallel, convergent, or sympleiomorphic: wing-flexing, in some ancient Paleoptera (Diaphanopteroidea); diminishing of wing corrugation, in some Recent Paleoptera (Ephemeroptera); deepening of wing corrugation, in higher Diptera and some Hymenoptera; immobilization of all pre-adult wings, in Pterygota; fusion of nymphal wing pads with terga, in Paleoptera and Neoptera-Exopterygota; reduction of the size of pre-adult wings, in Pterygota; bending of the nymphal wing-pads into the oblique-backward position, in Paleoptera; twisting of the nymphal wing pads about their points of attachment, in Odonata and Orthoptera; locking of the fore wings in the outstretched position for gliding, in various Neoptera; reducing ancestral

nymphal tubular venation to surface ridges, in modern Paleoptera and Neoptera-Exopterygota; reduction of prothoracic and terminal abdominal spiracles, in Pterygota; changing in-and-out pulsation of blood into a loop-like flow, in the wings of Paleoptera and Neoptera; development of special metamorphic instars to compensate for reduction and immobilization of nymphal wings, in all modern Pterygota.

The use of both convergent and sympleiomorphic characters for differential diagnostic purposes creates an artificial polyphyly and undesirable "parasystems" (pseudophylogenetic systems), which give the false impression that it is arbitrarily possible to classify insects by means of several types of systems. In reality, *there is only one possible system* which reflects the actual phylogenetic path. All other classifications (i.e., that of Lemche, '42) are of necessity based upon outer resemblance of characters which often has very little to do with the phylogeny. Examples of parasystems are the following: classification of insects into Ametabola and Metabola; of Pterygota into Hemimetabola and Holometabola; of Pterygota into Opisthoptera (=Ephemeroptera and Neoptera) and Plagioptera (the rest of Paleoptera); and of insects into Monocondylia and Dicondylia, etc. These parasystems are based upon metamorphosis, orientation of nymphal wing pads, and stage of development of the anterior mandibular articulation. I believe that all these features developed several times, independently in both Paleoptera and Neoptera, and *do not represent the basic apomorphic characters* (key characters) in Pterygota.

The classical example of artificial polyphyly is the separation of Odonata from other Paleoptera, or even from all Pterygota (Mackerras, '67; Kristensen, '75; Matsuda, '65, '70, '76) on the basis of a misreading of secondary apomorphic characters such as: "missing" veins, the specialized mechanism of mating, the "lack" of a telsonal appendix, the presence of a dicondylous mandible, details of head structure, derived morphology of the thorax, "different" pteralia, tracheation, "peculiar" orientation of nymphal wings, etc. Most of these differences have been discussed here on phylogenetic grounds or are found to be homologous with features of other Paleoptera through the "closing the gap effect" of the fossil evidence and will be described in

future publications; others are currently being interpreted as homologous in a large-scale comparative morphological study (E. L. Smith, California Academy of Sci., personal communication in 1976).

To some entomologists it might seem to be asking too much to believe that so many insect characters originated and developed at different rates and achieved by parallel evolution in separate lineages such a remarkably high degree of morphological resemblance. However, this type of evolution is frequent throughout the Animal Kingdom, and especially in insects (Mackerras, '67; Hinton, '55; and others). Indeed, parallel development, as an alternative to homology, is a more significant agent in evolution than has been recognized.

De Beer ('71) analyzed parallelism in which a complicated mechanism (such as the tracheae in Arthropoda) evolved repeatedly and separately within groups of organisms which are related on an embryological and morphological level. He pointed out that certain parallelism, called by him *latent homology*, conveys the impression that beneath the homology of the phenotype, there is a genetically based homology which can provide further evidence of affinity between the groups. Many cases of parallelism are most likely genetically based and are thus, in a sense, homologous. Similarities in two or more genetic lines that develop in parallel are channeled *mainly by a common ancestry* and not principally by environmental selective pressures (which cause convergence). Compared to this, only those features which can be traced back to the *same* (or an equivalent) feature in the *common ancestor* of a particular taxon are homologous (Mayr, '63).

The importance of parallelism and its impact on the evaluation of characters is not yet fully recognized by comparative morphologists and taxonomists. At present, the prevailing philosophy seems to be that related and descendent (i.e., homologous) structures are all those which: 1. look the same, 2. have similar position, attachment, etc. and 3. are being served by similar musculature. One goal of this paper has been to show that the possible kinds of relationships can be more subtle and much more varied than this.

#### ACKNOWLEDGMENTS

This paper is dedicated to Professor F. M. Carpenter (Harvard University, Cambridge) in recognition of his contributions to insect

paleontology and evolution, and of the 20 years of encouragement and support that he has given to my work. This does not mean that he agrees with all the conclusions presented here. My husband, Dr. Stewart B. Peck (Carleton University, Ottawa), also made this work possible through his help, support, and encouragement. I am specially indebted to Doctor M. C. Parsons (University of Toronto), Mr. A. Downes, Doctor J. W. Arnold, Doctor J. F. McAlpine, and Doctor E. Lindquist (Biosystematic Research Institute, Ottawa) as well as to Doctor H. Howden (Carleton University, Ottawa), and Doctor V. Pokorný (Charles University, Prague), for reading earlier drafts of this paper and for suggesting significant improvements. Doctor E. L. Smith (California Academy of Sciences, San Francisco) made a number of very useful observations. Doctor F. Sehnal (Czechoslovak Academy of Science, Prague) provided consultations on metamorphosis which contributed significantly to my conclusions.

The fossil material used in this paper was made available for study through the courtesy of the following people and institutions: Doctor V. Pokorný, Charles University, Prague; Doctor F. M. Carpenter, Museum of Comparative Zoology, Harvard University, Cambridge; Doctor E. S. Richardson, Jr., Field Museum of Natural History, Chicago; Doctor C. L. Remington and Mrs. J. S. Lawless, Peabody Museum, Yale University, New Haven; Doctor B. B. Rohdendorf, Paleontological Institute of the Academy of Sciences, Moscow; Doctor J. P. Lehman, Muséum d'Histoire Naturelle, Paris; and Doctor P. E. S. Whalley, British Museum (Natural History), London. The study was aided by three books on insect morphology by Doctor R. Matsuda (Biosystematic Research Institute, Ottawa) which opened the door to the literature on the subject. To Doctors J. Moore and K. Hooper (Department of Geology, Carleton University, Ottawa) I am very thankful for the provision of working space and research facilities.

Field, museum, and laboratory studies have been supported personally by my husband, by grants to Professor F. M. Carpenter from the U.S. National Science Foundation, and by operating grants to me from the Canadian National Research Council, and the Penrose Fund of the Geological Society of America.

#### LITERATURE CITED

- Adams, A. 1958 The relationship of the Protopleraria and the Endopterygota. *Psyche*, 65 (4): 115-127.

- Adolf, G. E. 1879 Ueber Insektenflügel. Nova Acta Leop. Carol., 41: 215-291.
- Alexander, R. D., and W. L. Brown 1963 Mating behavior and the origin of insect wings. Occas. Papers Mus. Zool. Univ. Mich., 628: 1-19.
- Arnold, J. W. 1963 A note on the pterostigma in insects. Can. Ent., 95 (1): 13-16.
- 1964 Blood circulation in insect wings. Mem. Entomol. Soc. Can., 38: 5-48.
- Bekker, E. G. 1952 Problem of the origin of the insect wing. Part I. Forerunners of the insect wing. Vestnik Moskovsk. Univ., 9: 59-68 (in Russian).
- Birket-Smith, J. 1971 The abdominal morphology of *Povilla adusta* Navas (Polymyrtaridae) and of Ephemeroptera in general. Entomol. Scand., 2: 139-160.
- Bocharova-Messner, O. M. 1959 Development of the wing in the early post-embryonic stage in the ontogeny of dragonflies (order Odonata). Trudy Inst. Morf. Zhiv. Im. Severtsova, 27: 187-200 (in Russian).
- 1965 Ontogeny of the skeleton and muscles of the thoracic division in *Baetis* sp. (Baetidae, Ephemeroptera). Zool. zh., 44 (12): 1790-1799 (in Russian).
- 1968 Principles of ontogenesis of pterothorax in Polyneoptera in relation with the problem of the origin in the evolution of the insectan flight apparatus. Voprosy funkts. morf. i embryol. nasek. Nauka, Moscow, pp. 3-26 (in Russian).
- 1971 On the origin of flight apparatus of insects. Proc. XIII. Int. Congr. Entomol. (Moscow), 1: 232.
- Bodenstein, D. 1950 The postembryonic development of *Drosophila*. In: Biology of *Drosophila*. M. Demerec, ed. Wiley, New York, pp. 275-367.
- Börner, C. 1908 Die Tracheenkiemen der Ephemeropteren. Zool. Anz.: 806-823.
- Borror, D. J., D. M. DeLong and Ch. A. Triplehorn 1964 An Introduction to the Study of Insects. Fourth ed. Holt, Rinehart & Winston, New York, pp. 1-852.
- Bradley, J. Ch. 1939 Laboratory Guide to the Study of the Evolution of the Wings of Insects. Second ed. Wickersham Print. Co., Lancaster, Pa, pp. 1-59.
- 1942 The origin and significance of metamorphosis and wings among insects. Proc. VIII. Pan Amer. Sci. Congr., Biol. Sec., 3: 303-309.
- Brodskii, A. K. 1974 Evolution of the wing apparatus in the Ephemeroptera. Entomol. Obozr., 53 (2): 291-303.
- Brues, Ch. T., A. L. Melander and F. M. Carpenter 1954 Classification of insects. Bull. Mus. Comp. Zool., 108: 1-917.
- Calvert, P. 1911 Studies on Costa Rican Odonata. The larva of *Cora*. Ent. News a. Proc., Entomol. Sec., 22 (2): 49-64.
- Carpenter, F. M. 1933 The Lower Permian insects of Kansas. Part 6. Deloptera, Protelytroptera, Plecoptera and a new collection of Protodonata, Odonata, Megaseoptera, Homoptera, and Psocoptera. Proc. Amer. Acad. Arts & Sci., 68 (110): 411-503.
- 1935 The Lower Permian insects of Kansas. Part 7. The order Protoperlaria. Proc. Amer. Acad. Arts & Sci., 70: 103-146.
- 1940 A revision of the Nearctic Hemerobiidae, Berothidae, Sisyridae, Polystoechoetidae and Dilaridae (Neuroptera). Proc. Amer. Acad. Arts & Sci., 74 (7): 193-280.
- 1950 The Lower Permian insects of Kansas. Part 10. The order Protorthoptera: the family Liomopteridae and its relatives. Proc. Amer. Acad. Arts & Sci., 78: 187-219.
- 1951 Studies on Carboniferous insects from Commentry, France; Part II. The Megaseoptera. J. Paleont., 25 (3): 336-355.
- 1966 The Lower Permian insects of Kansas. Part 11. The orders Protorthoptera and Orthoptera. Psyche, 73 (1): 46-88.
- 1971 Adaptation among Paleozoic insects. Proc. N. Amer. Paleont. Conv., Sept. 1969, 1: 1236-1251.
- 1976 Geological history and evolution of the insects. Proc. XV. Int. Congr. Entomol., Washington, D.C. 1: 63-70.
- Carpenter, F. M., and E. S. Richardson, Jr. 1968 Megaseopteran nymphs in Pennsylvanian concretions from Illinois. Psyche, 75: 295-309.
- Chapman, R. F. 1969 The Insect Structure and Function. English Univ. Press, London, pp. 1-819.
- Clare, S., and O. E. Tauber 1942 Circulation of haemolymph in the wings of the cockroach, *Blattella germanica* L. III. Iowa State. Coll. J. Sci., 16: 349-356.
- Comstock, J. H. 1918 The Wings of Insects. Comstock Publishing Co., Ithaca, New York, pp. 1-430.
- Comstock, J. H., and J. G. Needham 1898-1899 The wings of insects. Amer. Natur. 32, 33 (series of articles).
- Corbet, P. S. 1962 A Biology of Dragonflies. Witherby Ltd., London, pp. 1-247.
- Crampton, G. 1916 The phylogenetic origin and the nature of the wings of insects according to the paranotal theory. J. New York Entomol. Soc., 24: 267-301.
- De Beer, G. R. 1958 Darwin's views on the relation between embryology and evolution. J. Linn. Soc., London (Zool.), 44 (295): 15-23.
- 1971 Homology, an unsolved problem. In: Reading in Genetics and Evolution, 11. J. J. Head and O. E. Lowenstein, ed. Oxford Univ. Press, London, pp. 1-15.
- Dobzhansky, T. 1970 Genetics of the Evolutionary Process. Columbia Univ. Press, New York, pp. 1-505.
- Dürken, B. 1907 Die Tracheenkiemenmuskulatur der Ephemeropteren unter Berücksichtigung der Morphologie des Insektenflügels. Z. Wiss. Zool., 87: 435-550.
- 1923 Die postembryonale Entwicklung der Tracheenkiemen und ihrer Muskulatur bei *Ephemera ignita*. Zool. Jahrb., 44 (Anatomie): 439-613.
- Edmunds, G. F., and J. R. Traver 1954 The flight mechanics and evolution of the wings of Ephemeroptera, with note on the archetype insect wings. J. Wash. Acad. Sci., 44 (12): 390-400.
- Ewer, D. W. 1963 On insect flight. J. Entomol. Soc. Sth. Afr., 26: 3-13.
- Ewer, D. W., and L. S. Nayler 1967 The prothoracic musculature of *Deropeltis erythrocephala*, a cockroach with a wingless female, and the origin of wing movements in insects. J. Entomol. Soc. Sth. Afr., 30: 18-33.
- Flower, J. W. 1964 On the origin of flight in insects. J. Insect Physiol., 10: 81-88.
- Forbes, W. T. M. 1932 The axillary venation of the insects. Proc. V. Int. Congr. Entomol., 1: 277-284.
- 1943 The origin of wings and venational types of insects. Amer. Midl. Natur., 29: 381-405.
- Frazer, F. C. 1931 A note on the fallaciousness of the theory of pretracheation in the venation of Odonata. Proc. Roy. Entomol. Soc. London (A), 13 (4-6): 60-70.
- Grant, Ch. 1945 More on the origin of flight. Entomol. News, 61 (45): 243-245.
- Hamilton, K. G. A. 1971-72 The insect wing. Part I, II, III, IV. J. Kansas Entomol. Soc. 1971, 44: 421-433; 1972, 45: 54-58; 45: 145-162; 45: 295-308.
- Handlirsch, A. 1906 Die fossilen Insekten und die Phylogenie der rezenten Formen. Leipzig, pp. 1-430.
- Henke, K. 1953 Die Musterbildung der Versorgungssysteme in Insektenflügel. Biol. Zentralbl., 72: 1-51.
- Hennig, W. 1966 Phylogenetic Systematics. Univ. Illinois Press, Urbana, pp. 1-263.
- Hinton, H. E. 1955 On the structure, function and distribution of the prolegs of Panorpoidea, with a criticism of

- the Berlese-Imms theory. Trans. Roy. Entomol. Soc. London, 106: 455-545.
- 1963 The origin of flight in insects. Proc. Roy. Entomol. Soc. London (C), 28: 24-25.
- 1976 Enabling mechanisms. Proc. XV. Int. Congr. Entomol., Washington, D.C. 1: 71-83.
- Hocking, B. 1957 Aspects of insect flight. Sci. Month., 85: 237-244.
- Holdsworth, R. 1940 The history of the wing pads of the early instars of *Pteronarcys proteus* Newport (Plecoptera). Psyche, 47: 112-119.
- 1941 The wing development of *Pteronarcys proteus* Newman. J. Morph., 70: 431-461.
- Ide, F. R. 1936 The significance of the outgrowths of the prothorax of *Ecdyonurus venosus* Fabr. (Ephemeroptera). Can. Entomol., 68: 234-238.
- Imms, A. D. 1964 A General Textbook of Entomology. Methuen & Co., New York, pp. 1-886.
- Kristensen, N. P. 1975 The phylogeny of hexapod "orders." A critical review of recent accounts. Z. zool. Syst. Evolut.-forsch. 13: 1-44.
- Kukalová, J. 1958 Paoliidae Handlirsch (Insecta-Prothoptera) aus dem Oberschlesischen Steinkohlenbecken. Geologie, 7 (7): 935-959.
- 1964 Permian Insects of Moravia. Part II. Liomopteridea. Sbornik geol. věd, p. 3: 39-118.
- 1968 Permian mayfly nymphs. Psyche, 75 (4): 310-327.
- 1969-70 Revisional study of the order Palaeodictyoptera in the Upper Carboniferous shales of Commeny, France. Part I, 1969. Psyche, 76: 163-215; Part II, 1970. Psyche, 76: 439-486; Part III, 1970. Psyche, 77: 1-44.
- Kukalová-Peck, J. 1974a Wing folding in the Paleozoic insect order Diaphanopteroidea (Paleoptera), with a description of new representatives of the family Elmoidae. Psyche, 81 (2): 315-333.
- 1974b Pteralia of the Paleozoic insect orders Palaeodictyoptera, Megasecoptera, and Diaphanopteroidea (Paleoptera). Psyche, 81 (3-4): 416-430.
- 1975 Megasecoptera from the Lower Permian of Moravia. Psyche, 82 (1): 1-19.
- Kukalová-Peck, J., and S. B. Peck 1976 Adult and immature Calvertiellidae (Insecta: Palaeodictyoptera) from the Upper Paleozoic of New Mexico and Czechoslovakia. Psyche, 83 (1): 79-93.
- Kuntze, H. 1935 Die Flügelentwicklung bei *Philosamia cynthia* Drury, mit besonderer Berücksichtigung des Geäders, der Lakunen und der Tracheensystem. Z. f. Morph. u. Okol. d. Tiere, 30: 544-572.
- Lameere, A. 1923 On the wing venation of insects. Translation by A. M. Brues. Psyche, 30: 123-132.
- Landa, V. 1948 Contribution to the anatomy of ephemerid larvae. I. Topography and anatomy of tracheal system. Věstník čsl. zool. spol., 12: 25-82.
- Lemche, D. 1940 The origin of winged insects. Vidensk. Medd. natur. foren. (Copenhagen), 104: 127-168.
- 1942 The wings of cockroaches and the phylogeny of insects. Vidensk. Medd. natur. foren., 106: 288-318.
- Leston, D. 1962 Tracheal capture in ontogenetic and phylogenetic phases of insect wing development. Proc. Roy. Entomol. Soc., London (A), 37: 135-144.
- Locke, M. 1958 The co-ordination of growth in the tracheal system of insects. Quart. J. Micr. Sci., 99: 373-391.
- Mackerras, I. M. 1967 Grades in the evolution and classification of insects. J. Austr. Entomol. Soc., 6: 3-11.
- Mamajev, B. M. 1971 The significance of dead wood as an environment in insect evolution. Proc. XIII. Int. Congr. Entomol., Moscow, 1968, 1: 269.
- Marshall, W. S. 1913 The development of the wings of a caddis-fly, *Platyphylax designatus* Walker. Z. f. wiss. Zool., 105: 574-597.
- Martynov, A. V. 1925 Über zwei Grundtypen der Flügel bei den Insekten und ihre Evolution. Z. f. Morph. u. Okol., 4: 465-501.
- Matsuda, R. 1956 Morphology of the thoracic exoskeleton and musculature of mayfly *Siphonurus columbianus* McDunnough (Siphonuridae, Ephemeroptera). J. Kansas Entomol. Soc., 29: 92-113.
- 1965 Morphology and evolution of the insect head. Mem. Amer. Entomol. Inst., 4. Ann Arbor, Michigan, pp. 1-334.
- 1970 Morphology and evolution of the insect thorax. Mem. Entomol. Soc. Can., 76: 1-431.
- 1976 Morphology and Evolution of the Insect Abdomen. Pergamon Press, New York, pp. 1-534.
- Mayr, E. 1963 Animal Species and Evolution. Belknap Press, Harvard, Cambridge, pp. 1-797.
- Miller, A. 1940 Embryonic membranes, yolk cells, and morphogenesis of the stonefly *Pteronarcys proteus* Newman (Plecoptera: Pteronarcidae). Ann. Entomol. Soc. Amer., 33: 437-477.
- Müller, F. 1873 Beiträge zur Kenntnis der Termiten. Jena Z. Naturwiss., 7: 333-358, 451-563; 1975, 9: 241-264.
- Needham, J. G., J. R. Traver and Y. Hsu 1972 The Biology of Mayflies. Claxsey, England, pp. 1-759.
- Neville, A. C. 1960 Aspects of flight mechanics in anisopterous dragonflies. J. Exper. Biol., 37: 631-656.
- 1965 Energy and economy in insect flight. Science Progress, 53: 203-219.
- Novák, V. J. A. 1966 Insect Hormones. Methuen Co., London, pp. 1-477.
- Pringle, J. W. S. 1975 Insect flight. Oxford Biology Readers. J. J. Head, ed. Oxford Univ. Press, London, 52: 1-16.
- Rasnitsin, A. P. 1976 On the early evolution of insects and the origin of Pterygota. Zh. obschei biol., 37 (4): 543-555.
- Redtenbacher, J. 1886 Vergleichende Studien über das Flügelgeäder der Insekten. Annal. k. k. natur. Hofmus., 1: 153-232.
- Rees, Ch. J. C. 1975 Form and function in corrugated insect wings. Nature, 256 (July 17): 200-203.
- Rohdendorf, B. B. 1972 The Devonian Eoptera are not Insect but Crustacea Eumalacostraca. Entomol. Obozr., 51: 96-97 (in Russian).
- Ross, H. H. 1936 The ancestry and wing venation of the Hymenoptera. Ann. Entomol. Soc. Amer., 29 (1): 99-111.
- 1955 The evolution of the insect orders. Entomol. News, 66 (8): 197-208.
- Ross, M. H. 1964 Pronotal wings in *Blattella germanica* (L.) and their possible evolutionary significance. Amer. Midl. Natur., 71: 161-180.
- Scudder, G. G. E. 1973 Recent advances in the higher systematics and phylogenetic concepts in entomology. Can. Entomol., 105 (9): 1251-1263.
- Sharov, A. G. 1957a Types of insect metamorphosis and their relationship. Rev. d'entomol. URSS, 36 (3): 569-576.
- 1957b Nymphs of Miomoptera in Permian strata of Kuznetzk Basin. Dokl. Akad. Nauk SSSR, 112 (6): 1106-1108.
- 1966 Basic Arthropodan Stock. Pergamon Press, New York, pp. 1-271.
- 1968 Phylogeny of Orthopteroid Insects. Nauka, Moscow, pp. 1-212 (in Russian).
- 1971a Habitat and relationship of Palaeodict-

- yoptera. Proc. XIII. Congr. Entomol., Moscow 1968, 1: 300-303.
- 1971b Morphological features and the way of life of Palaeodictyoptera. Dokl. 24 Chtenii pamiati N. A. Cholodkovskogo, Akad. Nauk SSSR, Moscow: 49-63.
- Smart, J. 1951 The wing venation of the American cockroach *Periplaneta americana* Linn. (Insecta: Blattidae). Proc. Zool. Soc. London, 121 (3): 500-509.
- 1953 The wing venation of the migratory locust (*Locusta migratoria* Linn.) (Insecta: Acrididae). Proc. Zool. Soc. London, 123: 204-217.
- 1956 A note on insect wing veins and their tracheae. Quart. J. Micro. Sci., 97 (4): 535-539.
- Smith, E. L. 1970a Biology and structure of the dobsonfly, *Neohermes californicus* (Walker) (Megaloptera: Corydalidae). Pan-Pacif. Entomol., 46 (2): 142-150.
- 1970b Biology and structure of some California bristletails and silverfish. Pan-Pacif. Entomol., 46 (3): 212-225.
- Snodgrass, R. F. 1935 Principles of Insect Morphology. McGraw-Hill, New York, pp. 1-667.
- 1952 A Textbook of Arthropod Anatomy. Comstock Publishing Assoc., Ithaca, New York, pp. 1-363.
- Spieth, H. T. 1932 A new method of studying the wing veins of the mayflies and some results obtained therefrom. Entomol. News, 43 (32): 103.
- Sulc, K. 1911 Über Respiration, Tracheensystem, und Schaumproduktion der Schaumcikaden Larven. Z. f. wiss. Zool., 99: 147-188.
- Tillyard, R. J. 1926 Insects of Australia and New Zealand. Angus & Robertson, Sydney, pp. 1-560.
- Tower, W. L. 1903 The origin and development of the wings of Coleoptera. Zool. Jahrb., Anat., 17: 517-572.
- Tsui, P. T. P., and W. L. Peters 1972 The comparative morphology of the thorax of selected genera of the Lepidoptera (Ephemeroptera). J. Zool., (London), 168: 309-367.
- Wallace, F. L., and R. C. Fox 1975 A comparative morphological study of the hind wing venation of the order Coleoptera. Part 1. Proc. Entomol. Soc. Wash., 77 (3): 329-354.
- Weber, H., and H. Weidner 1974 Grundriss der Insektenkunde. Fischer, Stuttgart, pp. 1-640.
- Wheeler, W. M. 1889 The embryology of *Blatta germanica* and *Doryphora decemlineata*. J. Morph., 3 (2): 291-386.
- Whitten, J. M. 1962 Homology and development of insect wing tracheae. Ann. Entomol. Soc. Amer., 55: 288-295.
- Wigglesworth, V. B. 1950 The Principles of Insect Physiology. Dutton, New York, pp. 1-544.
- 1954 Growth and regeneration in the tracheal system of an insect *Rhodnius prolixus* (Hemiptera). Quart. J. Micro. Sci., 95: 115-137.
- 1963 The origin of flight in insects. Proc. Roy. Entomol. Soc., London (C), 28: 23-32.
- 1973 Evolution of insect wings and flight. Nature, 246 (5429): 127-129.
- 1974 Insect Physiology. Seventh ed. Chapman & Hall, London, pp. 1-166.
- 1976 The evolution of insect flight. In: Insect Flight. R. C. Rainey, ed. Symposia of Roy. Entomol. Soc. London, 7 (12): 255-269.
- Woodring, J. P. 1962 Oribatid (Acari) pteromorphs, pterogastrine phylogeny, and evolution of wings. Ann. Entomol. Soc. Amer., 55 (4): 394-403.
- Woodworth, C. W. 1906 The wing veins of insects. Univ. Calif. Publ., Tech. Bull., Entomol., 1 (1): 1-152.
- Wootton, R. J. 1972 Nymphs of Palaeodictyoptera (Insecta) from the Westphalian of England. Paleont., 15 (4): 662-675.
- 1976 The fossil record and insect flight. In: Insect Flight. R. C. Rainey, ed. Symposia of Roy. Entomol. Soc. London, 7 (12): 235-254.
- Zaleskii, J. M. 1953 Role of the wind in the origin of flight in insects. Priroda, 11: 85-90 (in Russian).
- Zwick, P. 1973 Insecta: Plecoptera. Phylogenetisches System und Katalog. Das Tierreich, 94: 1-465.

## Abbreviations

A, anal vein	DE, dorsal epidermis	MA, media anterior	ps, prescutoscutal sulcus	Te, tergum
ab, anal brace area	DL, dorsal layer	me, median lobe	R, radius	Tp, leg trachea
AC, axillary cord	En, endocuticle	MI, metamorphic instar	RI, radius anterior	Tsp, spiracular trachea
am, anterior margin	Es, episternum	mm, middle membrane	Rs, sector radii, radius posterior	um, subcoxo-coxal muscles
ap, apodermal pit	Ex, exocuticle	MP, media posterior	s, suralare	UM, muscles
bc, basicostale	f, fat body	n, notal median sclerite	Sc, subcosta	v, vein
bm, basement membrane	g, gonad	ne, abdominal nervous cord	sct, scutocutellar sulcus	VE, ventral epidermis
br, basal brace	G, gut	no, notch	scx, subcoxa	VL, ventral layer
bv, basivenale	h, hinge line	p, prealare	sp, spiracle	Vs, dorsal vessel
C, costa	HA, haemocoel	pa, paranotal sulcus	SV, spurious vein	W, wing (wing anlage)
cr, cross vein	IV, intercalated vein	pm, postmedian lobe	t, tegula	1,2,3,4, first, second, third
Cu, cubitus	k, patella	PNP, posterior notal wing process	T, longitudinal main sclerite	fourth axillary
CUA, cubitus anterior	m, median sclerite	pp, posterior arm of prealare	trachea	+
CUP, cubitus posterior	M, media	PRA, prealar bridge	Tb, gill trachea	-, concave vein
cx, coxal area				

## PLATE 1

## EXPLANATION OF FIGURES

- 1 Prothoracic winglets (arrow) in primitive Palaeodictyoptera, which were not fused with the prothorax, as indicated by their detached, upward folded, and superimposed position. The patella (k) is distinct from the tibia. *Lycocercus goldenbergi*; Upper Carboniferous, France. After Kukalova ('69-'70).
- 2 Tubular, corrugated, and pigmented venation in a paleozoic nymphal fore wing. *Protereisma* sp., Ephemeroptera; Lower Permian, Oklahoma. After Kukalova ('68). + and - , convex and concave veins.
- 3 Dorsal view of cleared whole mount of wing pad showing blood lacunae (channels stippled, C, Sc, R + M, Cu, A) that precede venation, in wing pads of modern nymphs. *Pteronarcys proteus*, Plecoptera; hind wing of fourth instar; Recent. After Holdsworth ('42).
- 4 Cross section through z---z level of figure 3. Lacunae (Cu + A) form only in the dorsal epidermis (DE); once within the wing pad, each lacuna (R + M, Sc, C) is completed by application of ventral epidermis (VE). Lacunae are deeply sunken, and are not connected with wing pad "venation" which is only composed of cuticular ridges. After Holdsworth ('42).
- 5 Primitive corrugation in paleopterous wing, formed by alternating veins. Convex veins (C+, RI+, etc.) are formed only in dorsal layer (DL), concave veins (C-, Sc-, Rs-, etc.) only in ventral layer (VL). *Siphonurus* sp., Ephemeroptera; wing, part of a cross section; Recent. After Edmunds and Traver ('54), the costa reinterpreted as fusion of C+ and C- according to new fossil evidence.

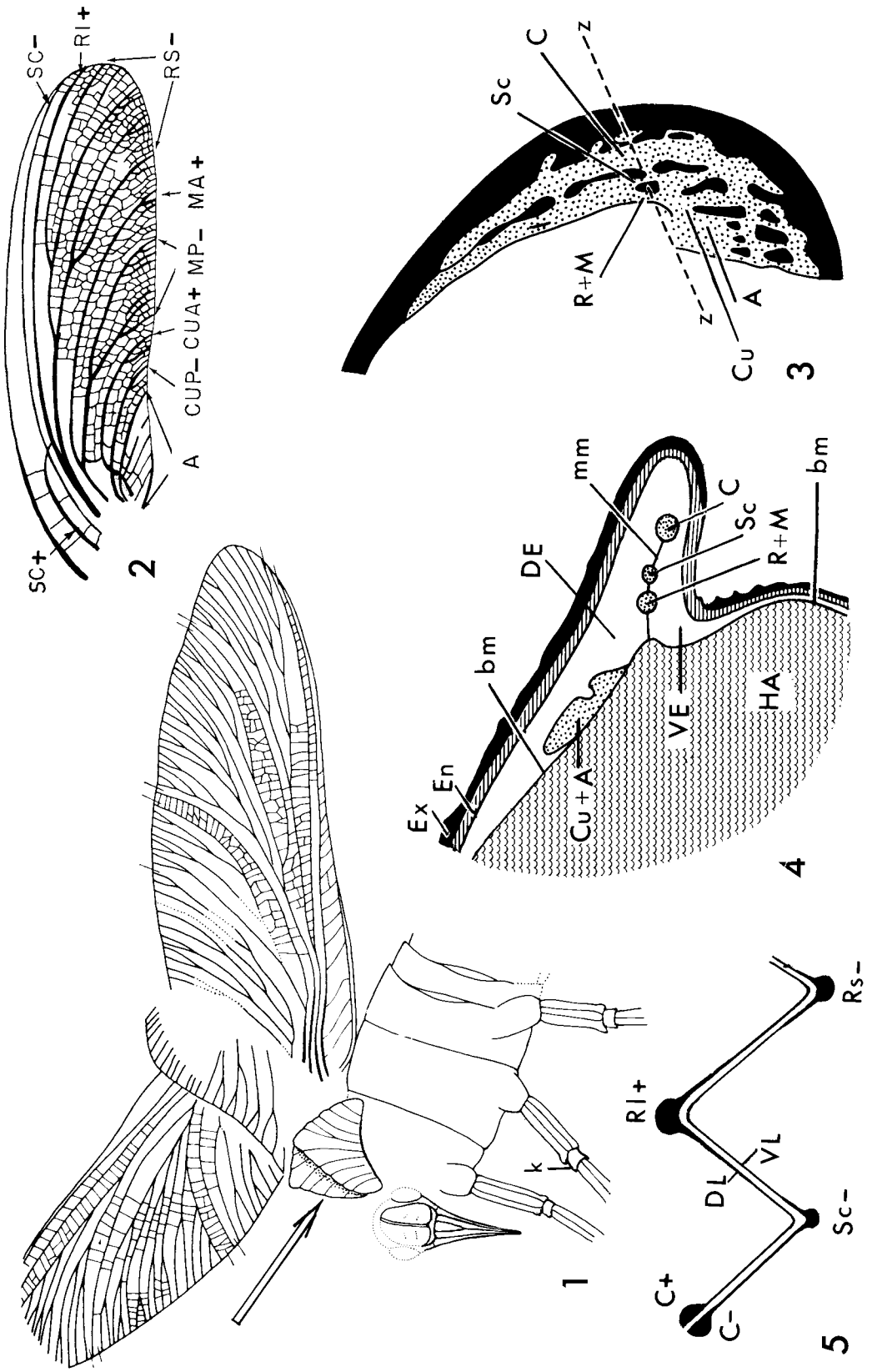
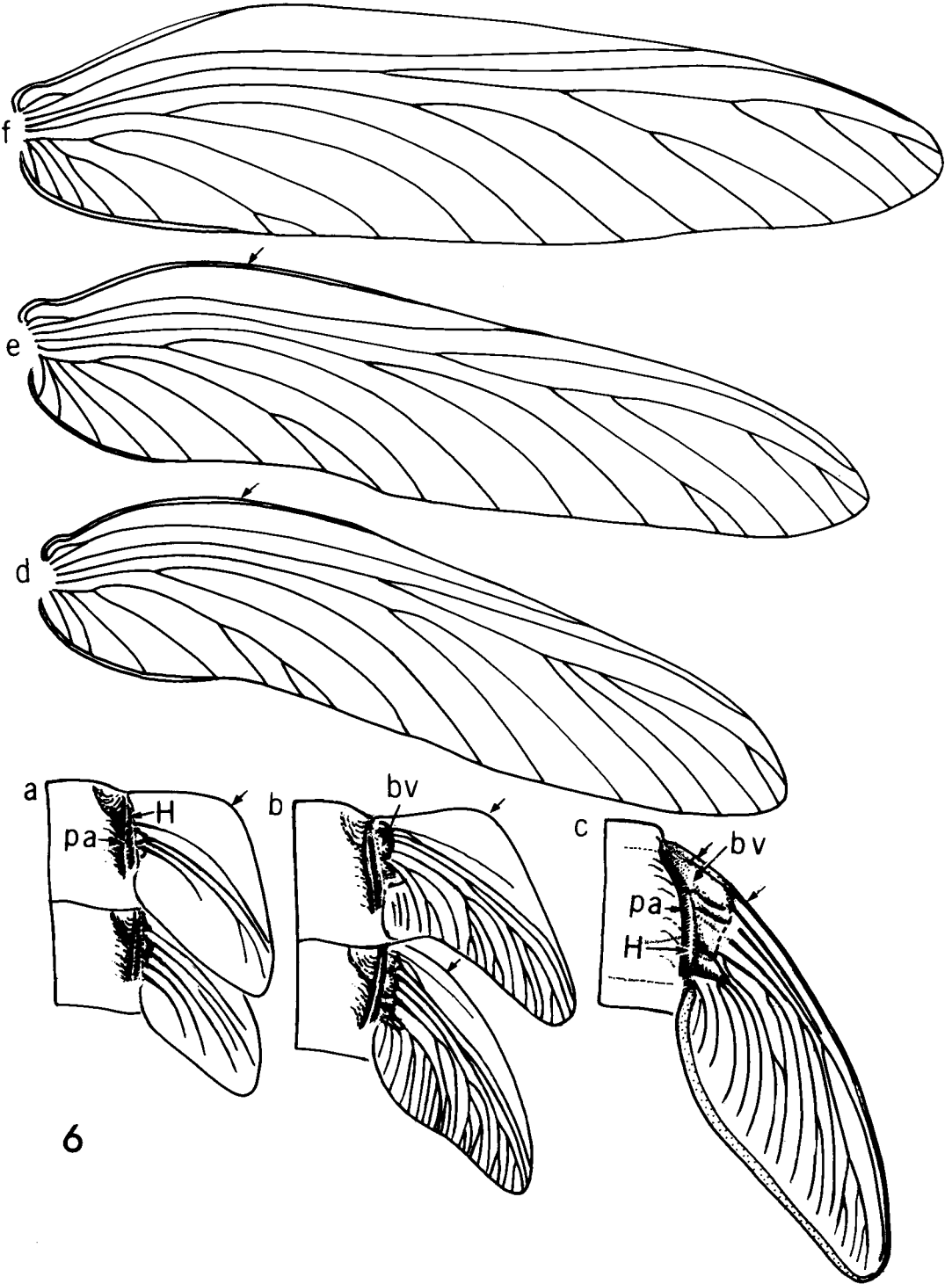

PLATE 2

EXPLANATION OF FIGURES

- 6 Ametabolous ontogenetic development characteristic for Paleozoic Paleoptera: young nymphs (a-c) had their winglets curved backwards by the nymphal wing bend (arrows); in subimago-like old nymphs (d,e) the wing axis was straightening gradually until imago (f) resulted. Convex hinge (H) ran between concave paranotal sulcus (pa) and flat basivenales (bv). Palaeodictyoptera: a. *Rochdalia parkeri*, young nymph; b. *Idoptilus onisciformis*, nymph; c. *Tschirkovaea* sp., nymph, hind wing; d. *Stenodictya perrieri*, subimaginal nymph, fore wing; e. *Stenodictya perrieri*, subimaginal nymph, fore wing; f. *Stenodictya agnita*, imago, fore wing; Upper Carboniferous, Europe. a,b, after Wootton ('72); d, f, after Kukalova ('69-'70); c, after Sharov ('71b) and Rasnitsin ('76); slightly altered.





6

PLATE 3

EXPLANATION OF FIGURES

- 7 Early paleopterous wing with completely preserved primitive set of alternating convex and concave veins, sectioned near the base to show vein pairs of the costa (C+, C-), the subcosta (Sc+, Sc-), and the anal (1A+, 2A-) which are usually obscured or inconspicuous in other insects. Specimen PE 16138, Field Museum, Chicago, primitive Homiopteridae, Palaeodictyoptera. Upper Carboniferous, Illinois. Original. A. Cross section through the anal brace area (ab, shaded). B. Cross section slightly distal from the anal brace (abr).
- 8 Cross section through modern paleopterous wing with reduced set of alternating convex and concave veins. *Aeshna* sp., Odonata; fore wing, distal from the arculus; Recent. Original.
- 9 Cross section through similar hind wings of: A. *Lemmatophora tupa*, plecopteroid Protorthoptera; Lower Permian, Kansas. B. *Sialis mohri*, Megaloptera; Recent. Both wings share an Rs + MA which is almost levelled with MP, and CuA sunken into an aerodynamic trough. After Adams ('58).
- 10 Cross section through elytron showing corrugation diminished by excessive cuticularization in both dorsal and ventral layers. Sc weakly preserves its concave position. *Prionus* sp., Cerambycidae, Coleoptera; Recent. Original.
- 11 Similar section as 10, but Sc has lost its concavity. *Eleodes* sp., Tenebrionidae, Coleoptera; Recent. Original.
- 12 Fore wing of a higher fly with accentuated corrugation supplemented by a highly convex spurious vein (SV). *Syrphus balteatus*, Diptera; Recent. After Rees ('72), slightly altered, interpretation of veins added (br-brace; cr-cross vein).
- 13 The same wings as in 12 in cross section. After Rees ('72), interpretation of veins added.

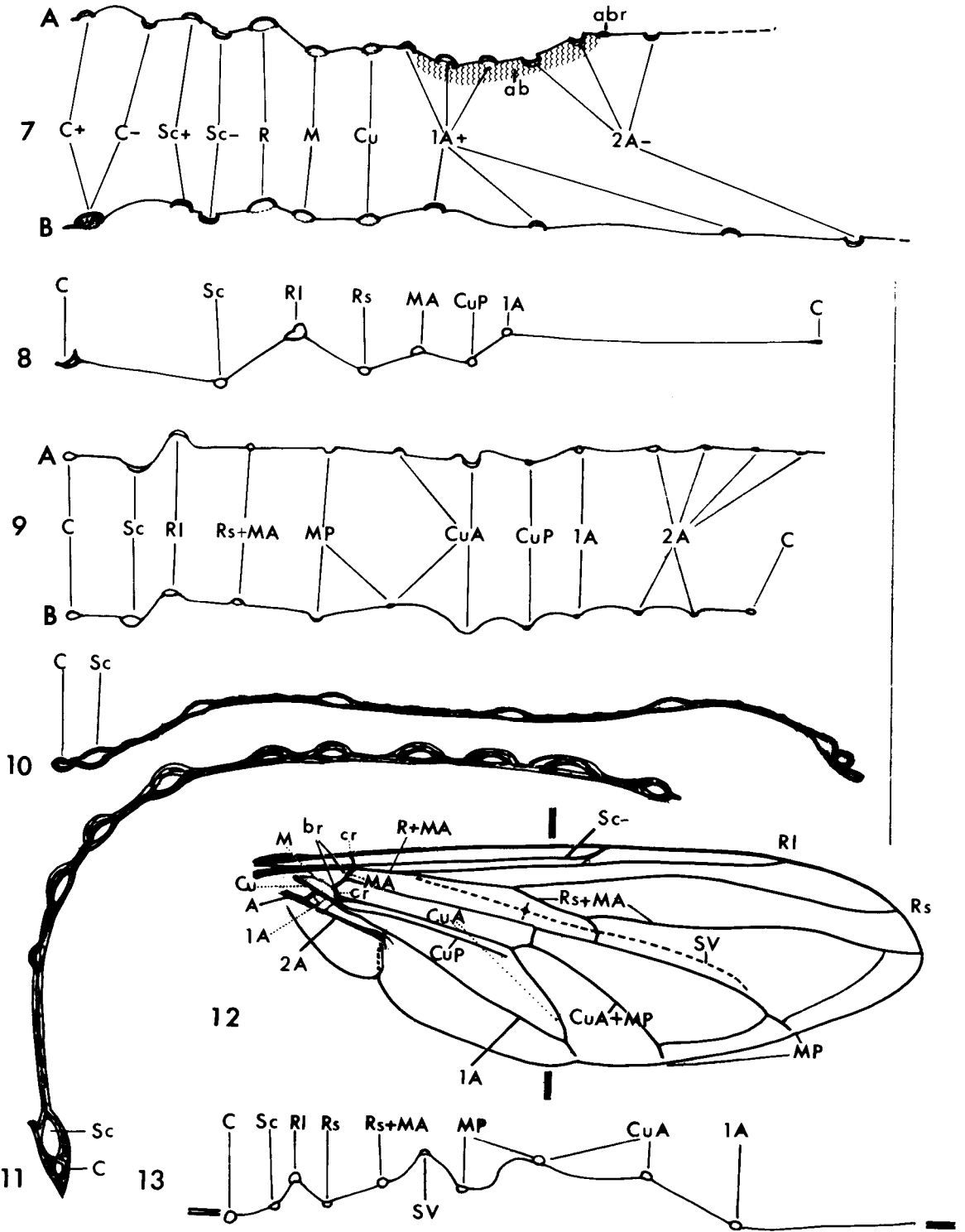
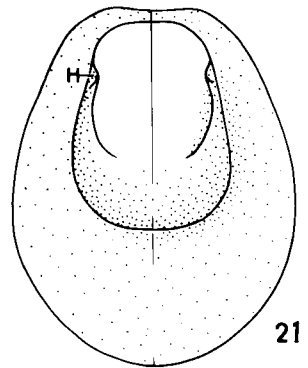
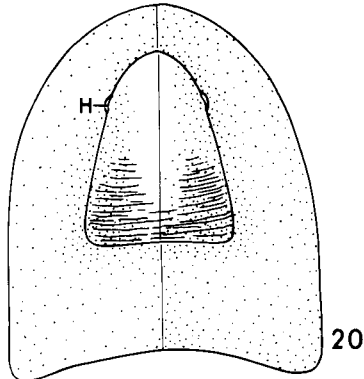
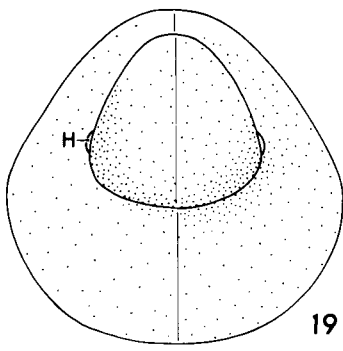
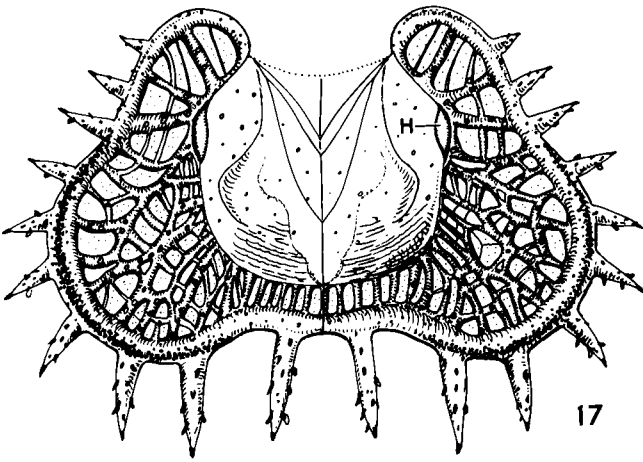
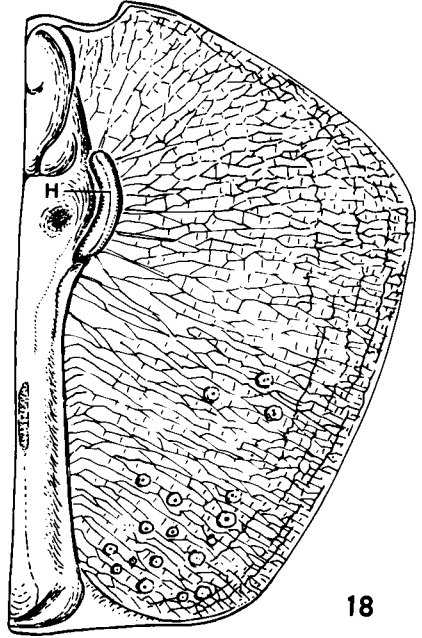
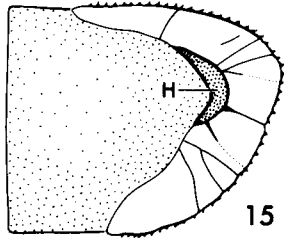
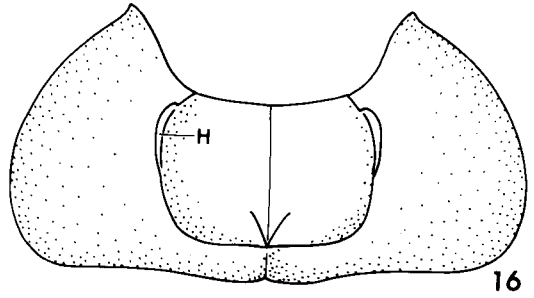
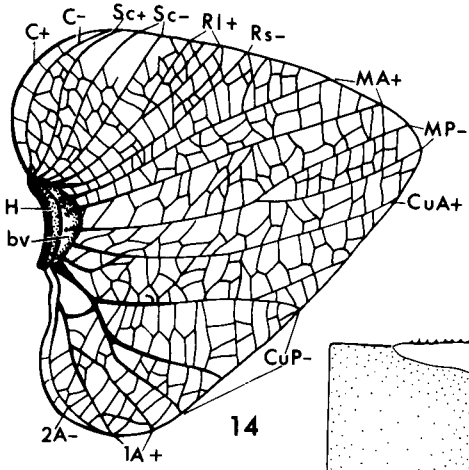

PLATE 4

EXPLANATION OF FIGURES

- 14 Most primitive known fossil prothoracic winglet, attached only at a rudimented hinge (H) and basivenales (bv). Venation is fan-like and weakly corrugated. *Stenodictya pygmaea*, Palaeodictyoptera; Upper Carboniferous, France. After Kukalova ('69-'70), new observations added.
- 15 Transformed prothoracic winglet of Paleozoic Ephemeroptera which became fused with protergum. *Protereisma permianum*, adult; Lower Permian, Kansas. Original (based upon specimen 3405b, Museum of Comp. Zoology, Harvard Univ.).
- 16 Transformed prothoracic winglets of Paleozoic Neoptera which shielded the legs. Specimen 1/1977, Charles Univ., Prague, Protorthoptera; Lower Permian, Czechoslovakia. Original.
- 17 Transformed prothoracic winglets of plecopteroid Protorthoptera which were strengthened by robust venation and spines covered with setae. Specimen 2/1977, Charles Univ., Prague; Lower Permian, Czechoslovakia. Original.
- 18 Transformed prothoracic winglets of a neotropical mantid, with rudimentary hinge (H) and secondary venation. Choeradodinae, Mantodea; Recent. Original.
- 19-21 Transformed prothoracic winglets of small Paleozoic roaches showing various positions of rudimentary hinge (H). Specimens 3/1977, 4/1977, 5/1977, Charles Univ., Prague; Lower Permian, Czechoslovakia. Originals.



## PLATE 5

## EXPLANATION OF FIGURES

- 22 Young nymph of Paleozoic terrestrial palaeodictyopteran, the winglets of which were articulated, but apparently afunctional (as a secondary adaptation); lateral parts of abdomen were formed by margined subcoxae (scx), not by "paranota" as previously expected. *Rochdalia parkeri*; Upper Carboniferous, England. After Wootton ('72). Original reconstruction.
- 23 Adult female palaeodictyopteran, showing prothoracic winglets attached only at rudimented hinge and abdomen with margined subcoxae (scx). *Stenodictya lobata*; Upper Carboniferous, France. After Kukalova ('69-'70).
- 24 Young nymph of Paleozoic terrestrial palaeodictyopteran with armored and flattened body; the wings are curved backwards and carry pteralia. *Idoptilus onisciformis*; Upper Carboniferous, England. After Wootton ('72). Original reconstruction from latex peel.

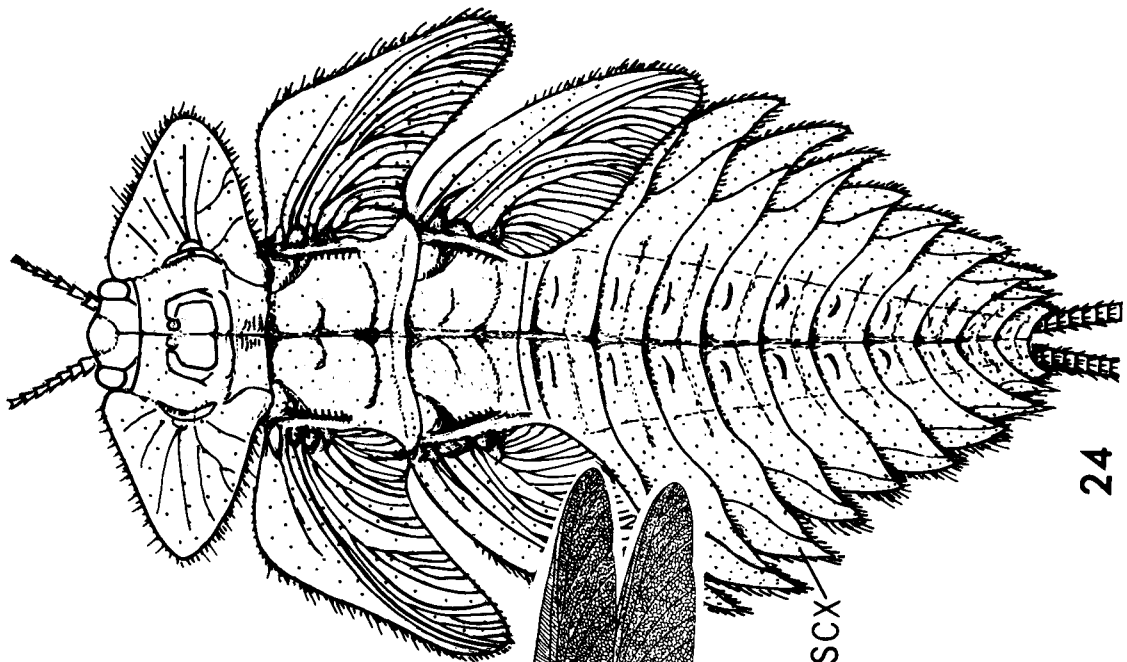

24

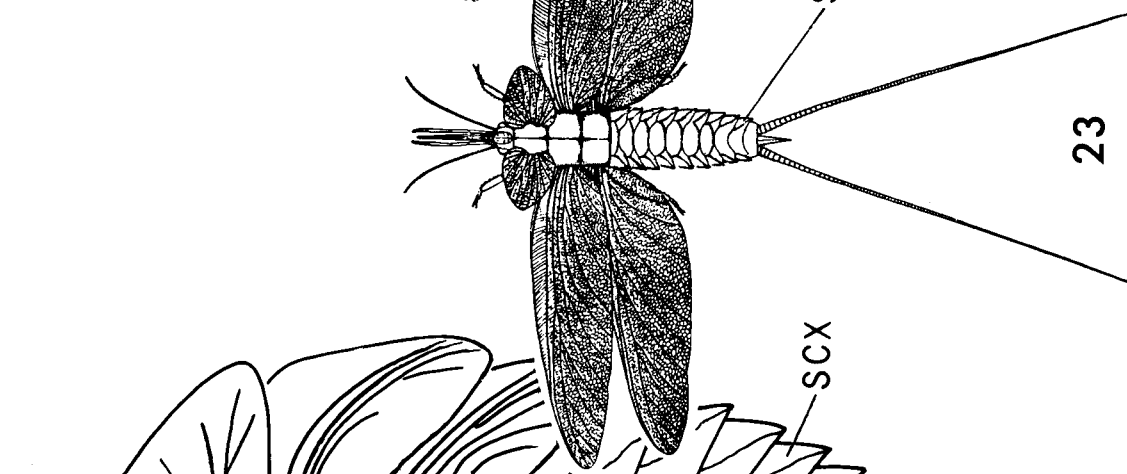

23

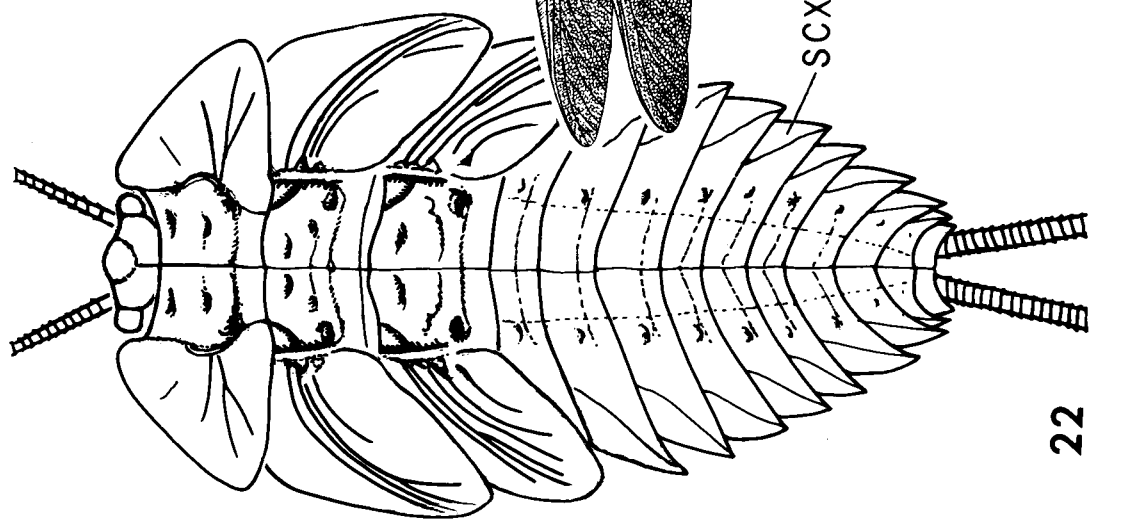

22

PLATE 6

EXPLANATION OF FIGURES

- 25 Pterygote abdominal wings. A. Lateral schematic view of middle abdominal segment of modern ephemerid nymph; cleared, showing subcoxo-coxal muscles (um), left gill-plate (wing) with veins (v) and strengthened anterior margin (am), articulated by fused basivenales (bv) between the margined subcoxa (scx) and the tergum (Te). Coxal area (cx) weakly indicated, spiracular anlage (\*, sp) not externally discernible. Original. B. Abdominal wings as found in primitive fossil Protorthoptera. Venation is very weakly preserved. *Quercopterum decussatum*, specimen 43/1963, Charles Univ., Prague, two of the anterior abdominal segments; Lower Permian, Czechoslovakia. Original observation in 1977, wings on the left side reconstructed.
- 26 Differences in fore and hind wing venation and corrugation of *Periplaneta americana*, Blattodea. Veins are convex (+), concave (-), or leveled (unmarked); Sc (+) is reduced to a weak fold; only concave M is labeled as MP. In the tegmen, most veins are leveled and branches of RI, Rs and part of M form an inseparable complex. In the hind wing 1A sends off anteriorly one to two branches; veins are corrugated near the base but are mostly leveled distally; Recent. Original.



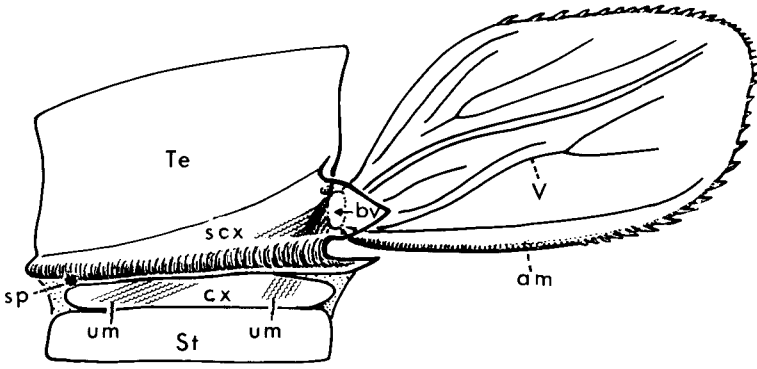

25A

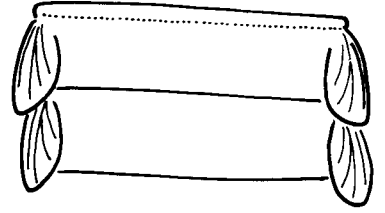

25B

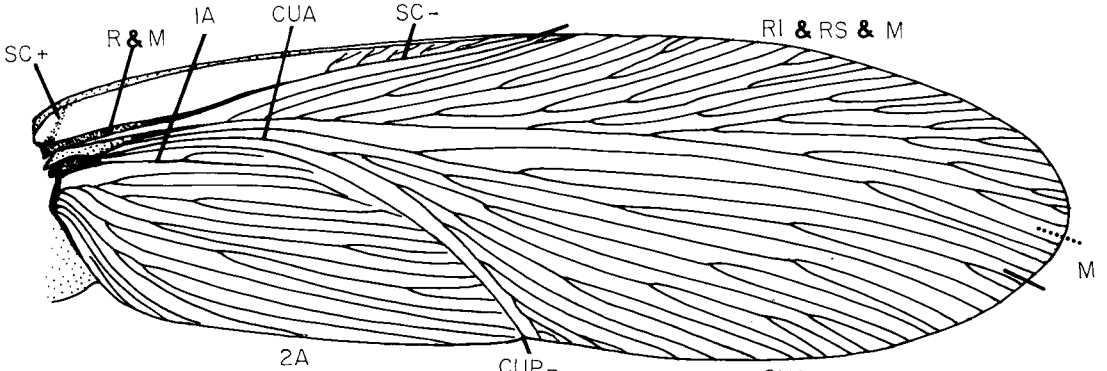

2A

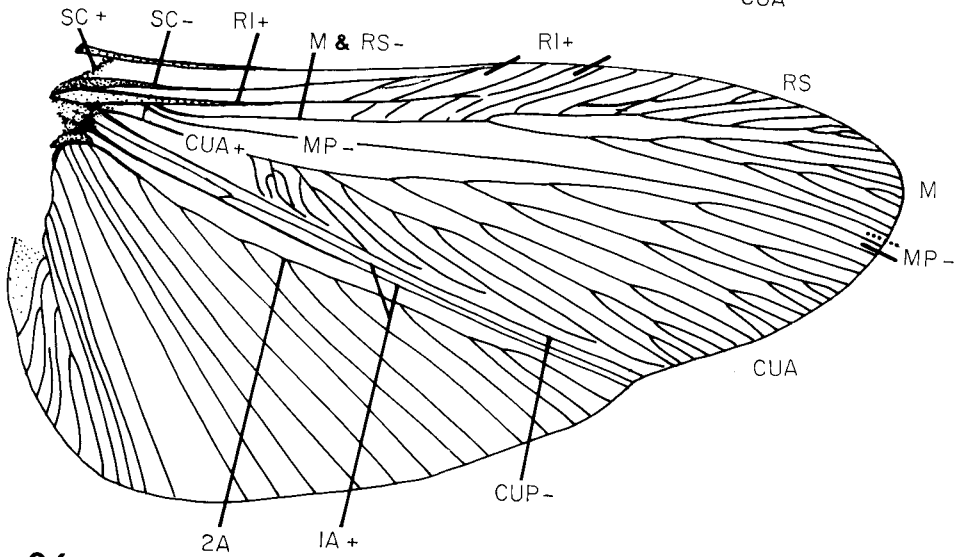

26

PLATE 7

EXPLANATION OF FIGURES

- 27 Besides Neoptera, wing flexing occurred in one extinct order of Paleoptera, the Diaphanopteroidea. *Phaneroneura* sp.; Lower Permian, Czechoslovakia. Original reconstruction from a complete specimen.
- 28 Typical Paleozoic mayfly, older nymph. Wings were curved backwards, articulated, and probably used for underwater rowing; prothoracic winglets were fused with protergum. Abdomen was equipped with nine pairs of veined wings. Legs were long, cursorial, with five tarsal segments. Protoreismatidae; Lower Permian, Oklahoma. After Kukulova ('68). Original reconstruction from a complete specimen.

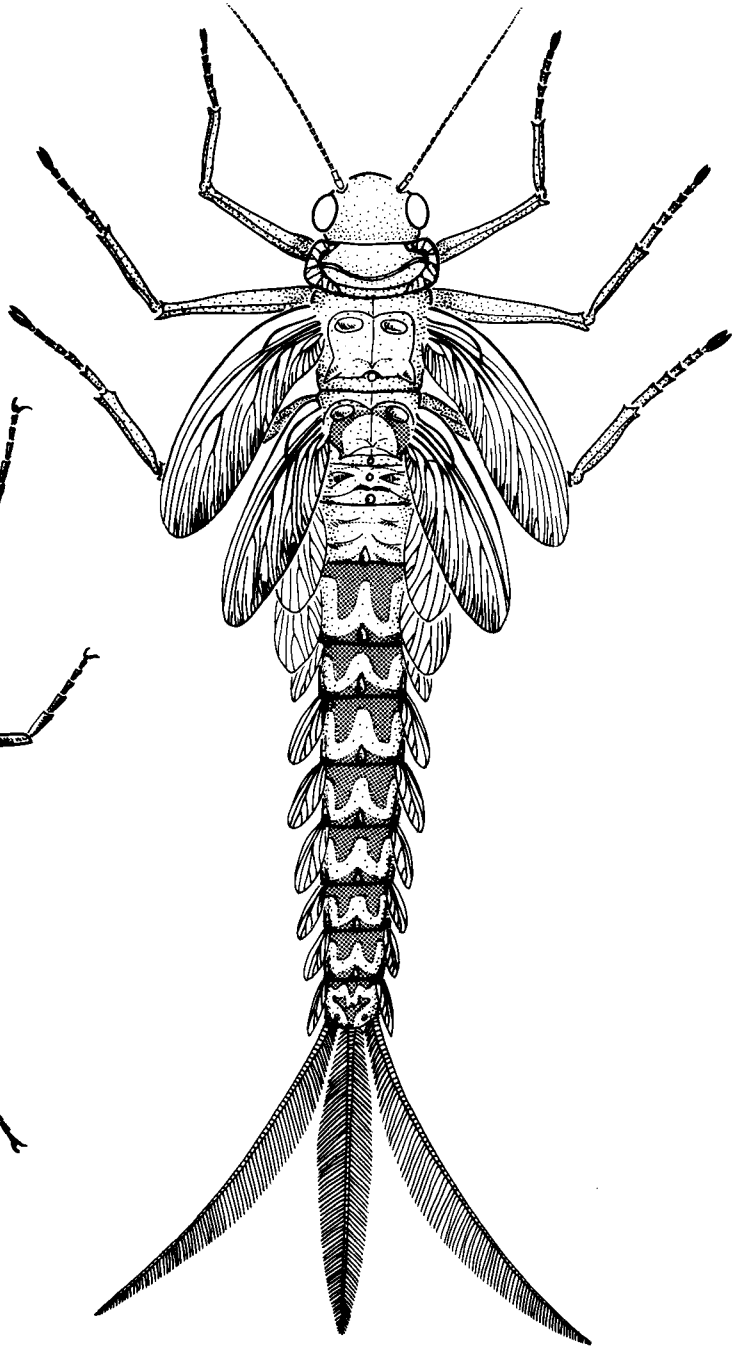
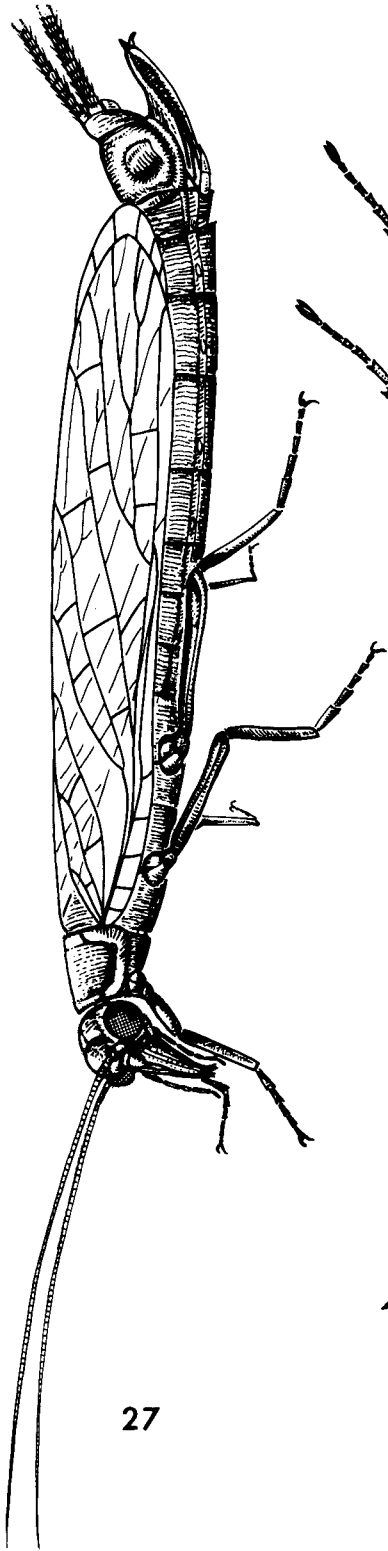

## PLATE 8

## EXPLANATION OF FIGURES

- 29 Metabolous development in Recent primitive mayflies (Siphonuridae), shortened and schematized. Wing pads are secondarily fused with the terga and suppressed in size; articulation, venation, and adult size are recovered during the metamorphic instar (MI). Original.
- 30 Ametabolous development typical for Paleozoic mayfly nymphs (Kukaloviidae). Wings were neither fused nor suppressed in size, but were articulated, veined and functional in forward motion. The wings were streamlined by being curved backwards by a nymphal wing bend (arrows) which gradually straightened in each subsequent older instar until the alar axis became perpendicular to the body in the adult (not shown); the metamorphic instar was not present because it was not "needed"; Lower Permian, Czechoslovakia. After Kukalova ('68). Original reconstructions from actual specimens.

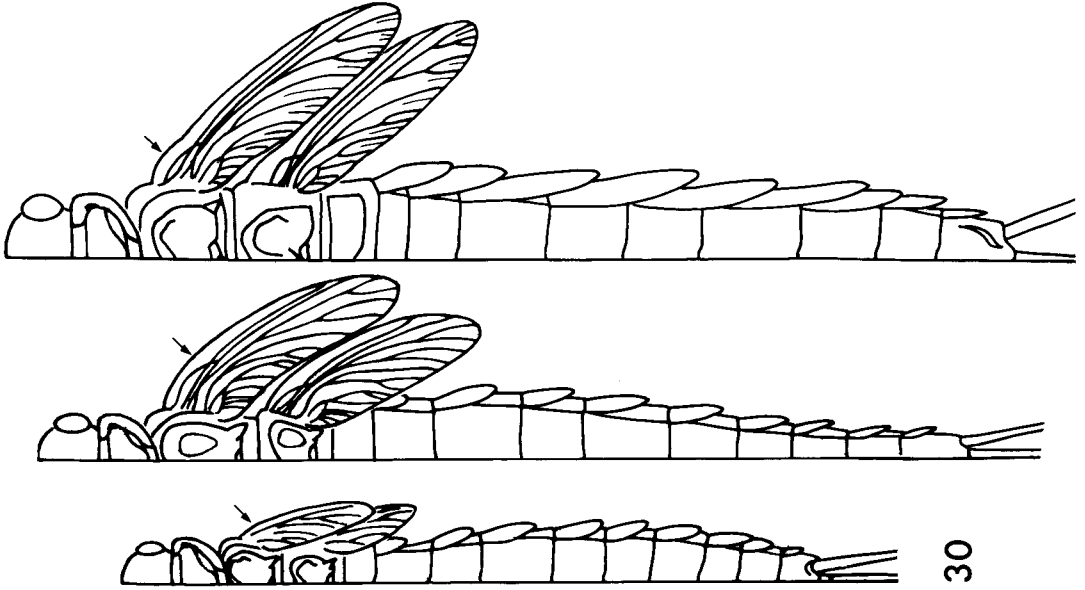

30

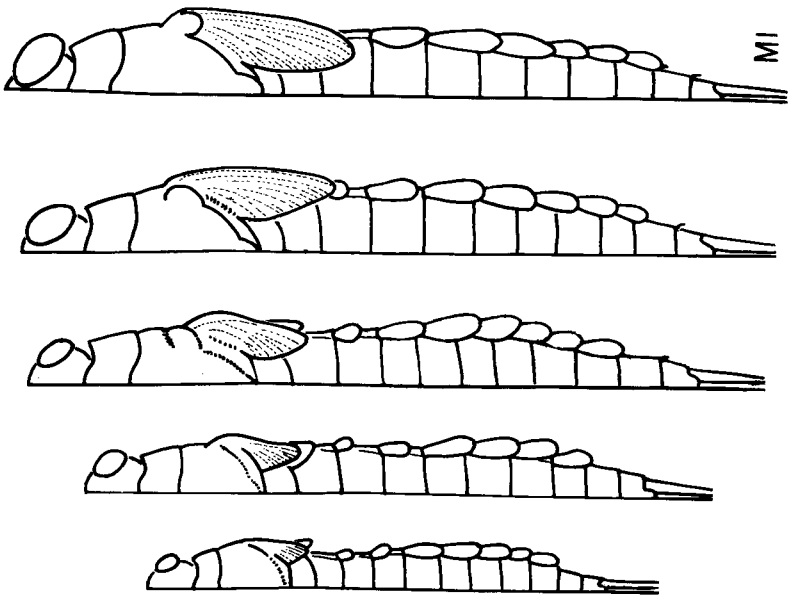

MI

29

PLATE 9

EXPLANATION OF FIGURES

- 31 Ametabolous paleopteran, terrestrial nymph with articulated wings curved backwards at nymphal wing bend (arrows) for easier movement; posterior margins of terga carried long integumental projections covered with setae. *Mischoptera douglassi*, Megasecoptera, young nymph; Upper Carboniferous, Illinois. After Carpenter and Richardson ('68). Original reconstruction.
- 32 Ametabolous paleopteran, adult (integumental projections are not figured). *Mischoptera nigra*, Megasecoptera; Upper Carboniferous, France. After Carpenter ('51).
- 33 Ametabolous neopteran, terrestrial nymph with articulated and movable wings which were not fused with the tergum as in modern metabolous Neoptera. *Atactophlebia termitoides*, plecopteroid Protorthoptera; Upper Permian, Urals. After Sharov ('57a).
- 34 Ametabolous primitive neopteran adult as they are sometimes found with incompletely flexed wings shown by the non overlapping of the wing tips. *Sylvioides perloides*, plecopteroid Protorthoptera; Lower Permian, Urals. After Sharov ('68).
- 35 Paleozoic nymph of a neopteran with wings on three thoracic and ten abdominal segments. Specimen 8592 ab, Museum of Comp. Zoology, Harvard Univ., young nymph, probably plecopteroid Protorthoptera; Lower Permian, Kansas. Original reconstruction after a complete specimen (fig. 48).

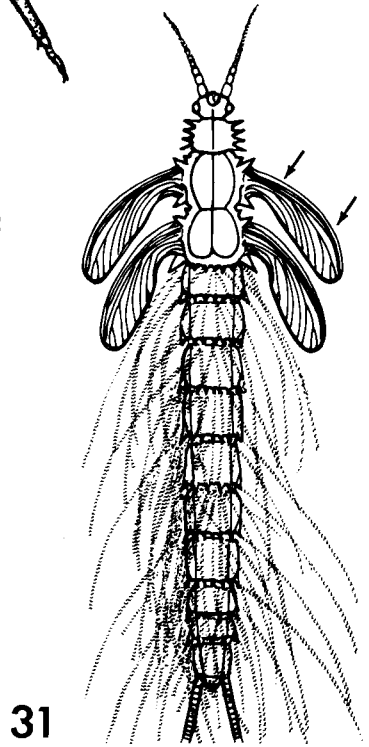
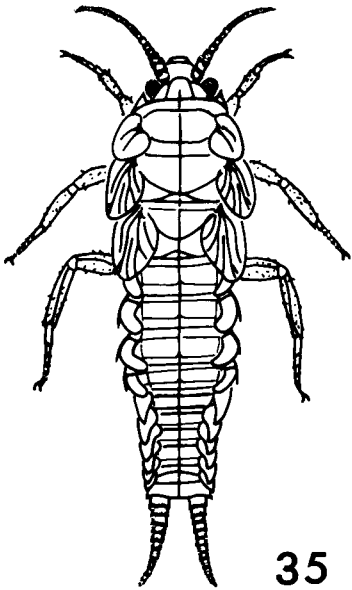
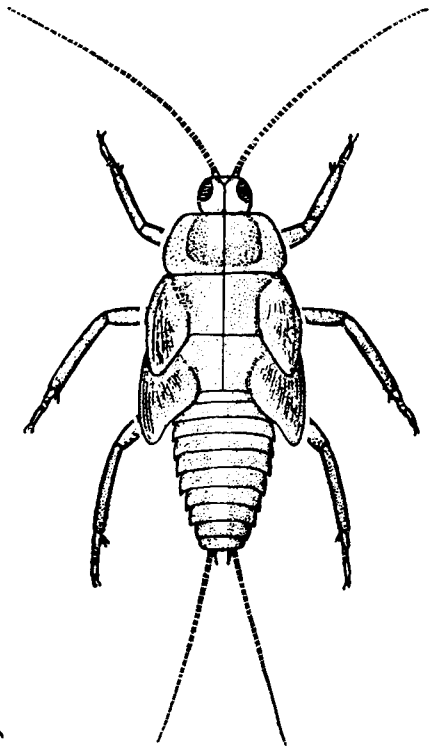
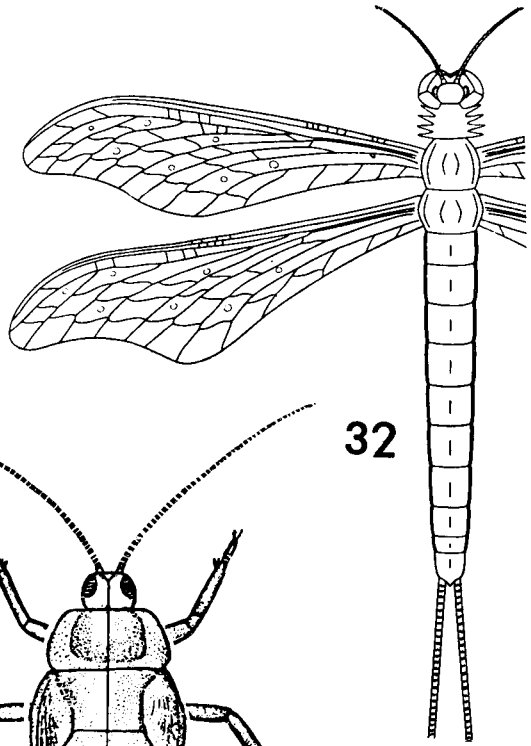
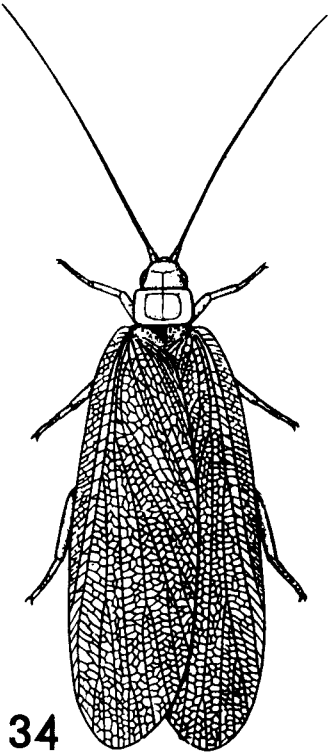

## PLATE 10

## EXPLANATION OF FIGURES

- 36 Ontogenetic development of wing (W) in modern dragonflies showing: an incipient epidermal thickening just above the spiracle (sp) in instar I and II; evaginated wing bud shifting towards the tergum (Te) in instar V; and posteriorly curved wing pad fused with the tergum resembling "paranotum" in instar VIII. *Libellula quadrimaculata*, Odonata; Recent. After Bocharova-Messner ('59).
- 37 Section through the sixth abdominal segment of first instar nymph of *Ephemerella ignita*, showing position of spiracular trachea (Tsp), gill muscle (um) and the anlage of future spiracle (sp); Ephemeroptera; Recent. After Dürken ('23).
- 38 Section through the fifth abdominal segment of fourth instar nymph of *Ephemerella ignita*, showing anlage of the gill-plate (W) in relation to the supposed subcoxo-coxal muscle (um); Recent. After Dürken ('23).
- 39 Frontal section through thorax of older nymph of *Ephemerella* sp., showing spiracular trachea (Tsp) and mechanically closed prothoracic spiracle (Sp); Recent. After Dürken ('23).
- 40 Section through an abdominal segment of nymph of *Heptagenia flava*, Ephemeroptera, showing intermediate position of spiracular trachea (Tsp) between the vestigial leg-(Tp) and gill-(Tb) trachea; Recent. After Landa ('48).



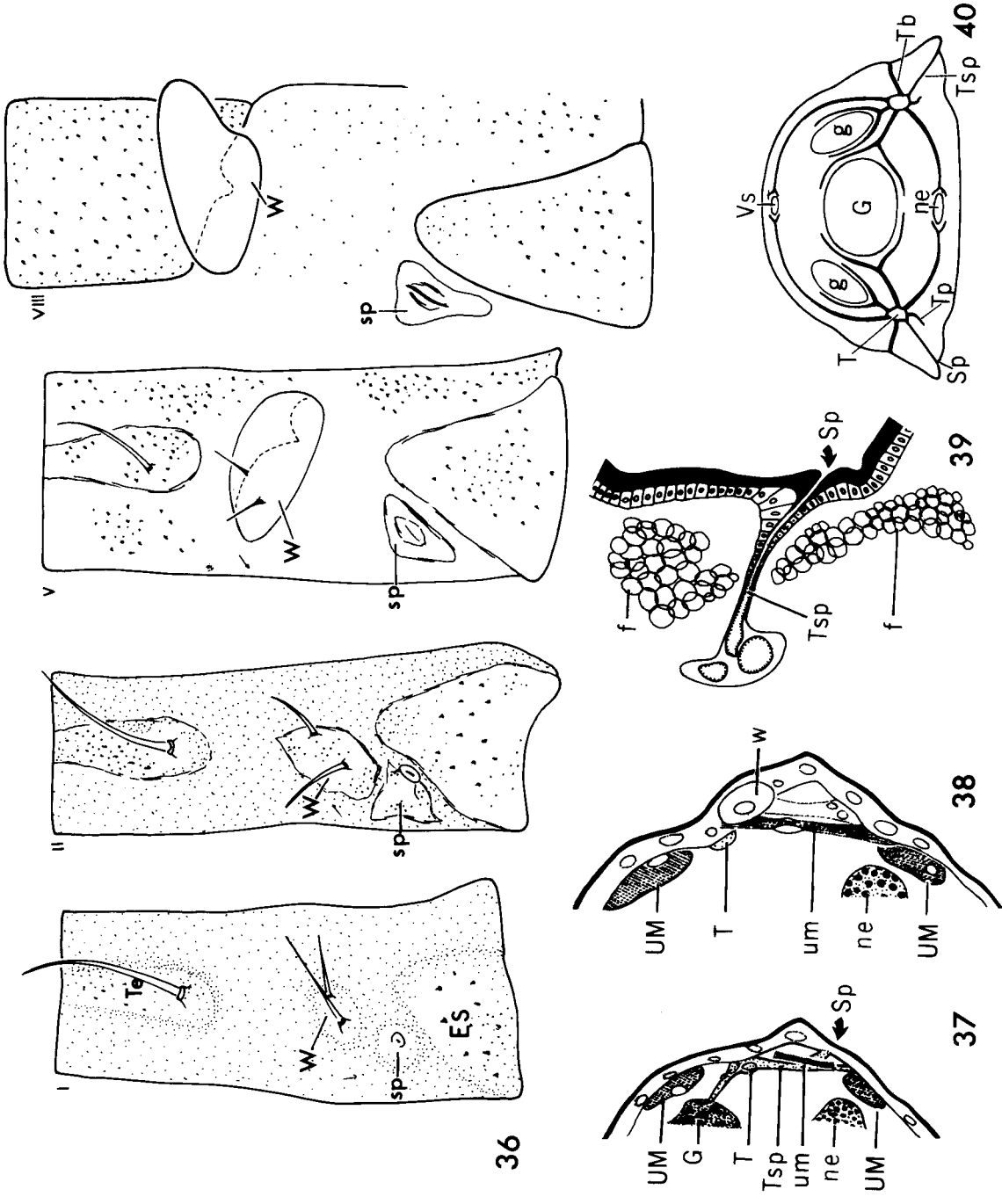

PLATE 11

EXPLANATION OF FIGURES

- 41 Blood circulation at the alar base in modern insects. Anterior veins are opened to afferent flow, while posterior veins are sealed by fused membrane (black) and are accessible only to efferent flow; channels with irregular edges represent regions where blood leaks between the basement membranes. *Blattella* sp., Blattodea; Recent. After Clare and Tauber ('42), slightly altered.
- 42 Parasagittal section of ephemerid thorax at base of fore wing shows fused basivenales (bv) as blood sinus carrying the afferent current, and axillary cord (AC) carrying the efferent current. *Hexagenia rigida*; Recent. After Arnold ('64).
- 43 Posterodorsal view of the wing base of a libellulid dragonfly showing the basicostale (bc) and the fused basivenales (bv) as active blood sinuses. Barrier between afferent-efferent flow is the dashed line. After Arnold ('64).
- 44 Typical loop-like blood circulation in modern insects. *Acroneuria arenosa*, Plecoptera. After Arnold ('64).

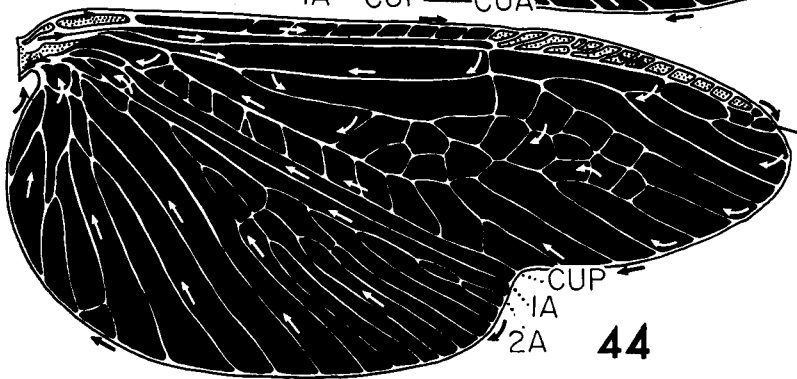
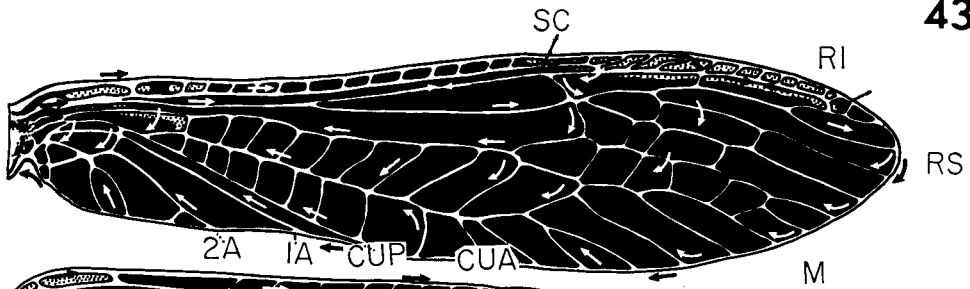
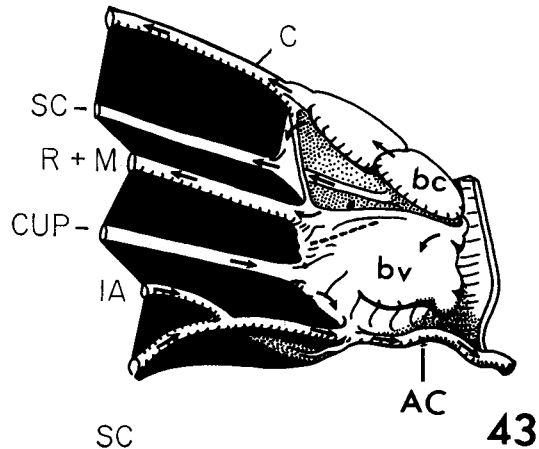
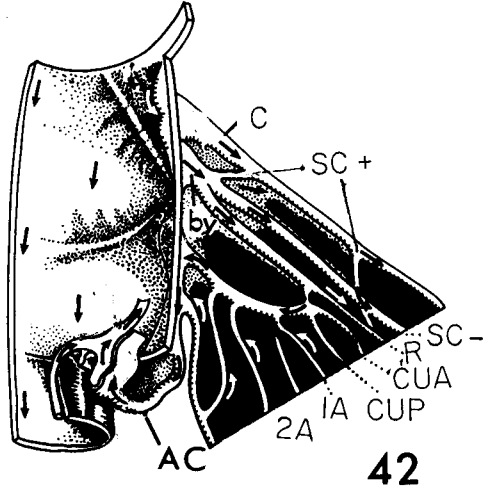
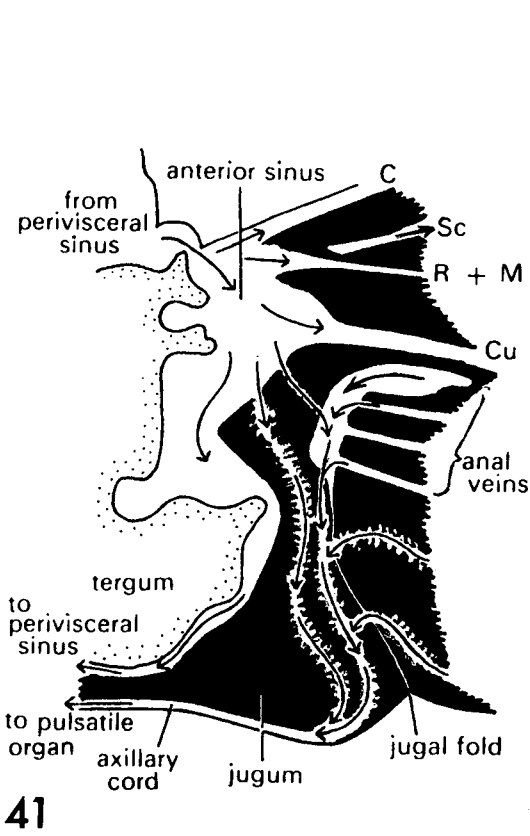
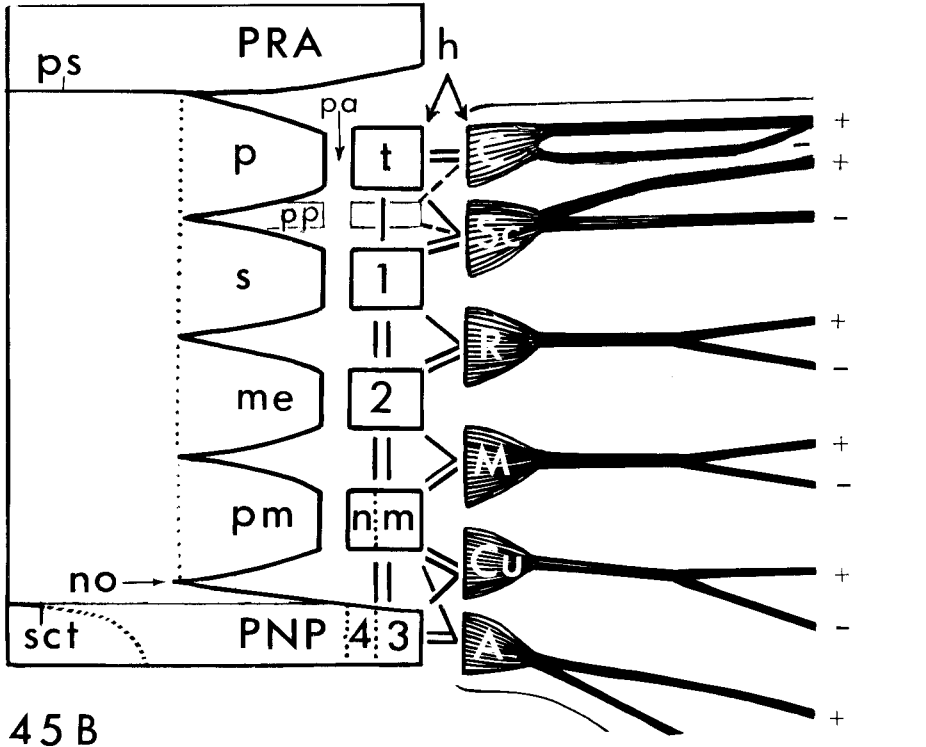
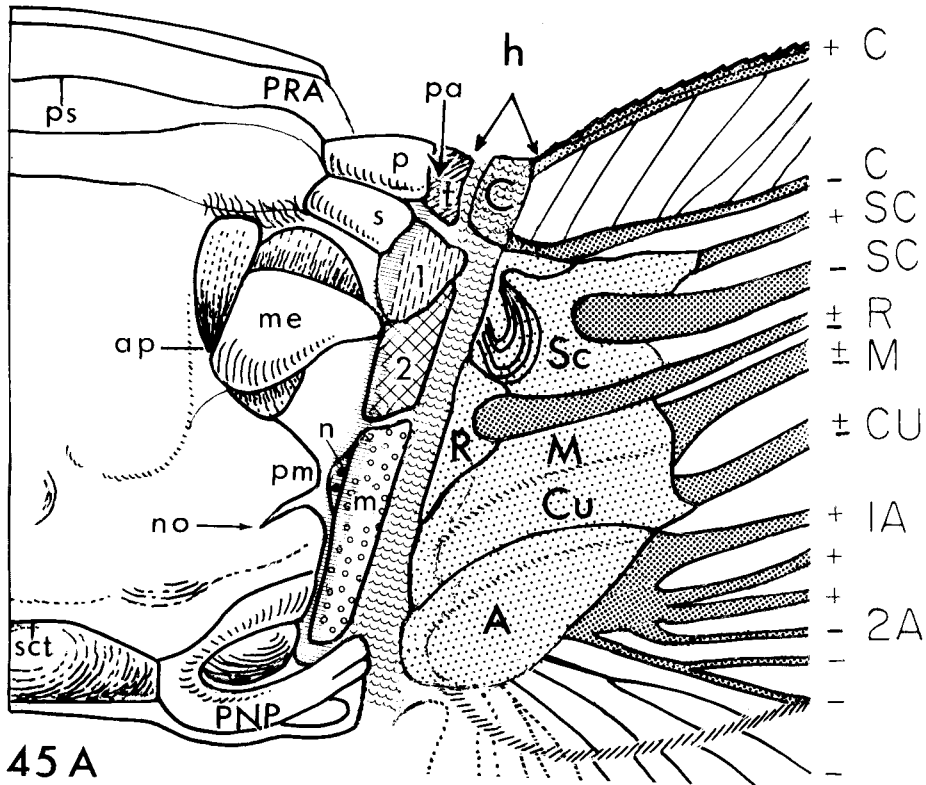

PLATE 12

EXPLANATION OF FIGURES

- 45 Most primitive known fossil pterygote hinge (in Palaeodictyoptera) (fig. 45A), and the schematic interpretation (fig. 45B) showing homology of all pteralia. The hinge line (h, scalloped lines) separates serial *tergal pteralia* (t, 1, 2, m) which are slanted mesally into the paranotal sulcus (pa, parallel lines), from serial *alar pteralia* (C, Sc, R, M, Cu, A) formed by flat, sclerotized veinal blood sinuses. Basicostale (C) functionally enters into the convex hinge line (widened for clarity). *Tergal pteralia* probably originated so that the tergum incised into the five lobes, prealare (p), suralare (s), median lobe (me), postmedian lobe (pm), and posterior notal wing process (PNP) separated by a notch (no); only Ephemeroptera and Odonata carry posterior arm of prealare (pp); from the lobes, the tegula (t) and the axillary sclerites (1, 2, m) detached serially along the paranotal sulcus (pa). Tegula and first and second axillary have been previously homologized. The median sclerite (m, nomen novum) of Recent Paleoptera was misinterpreted as the third axillary, but, is in fact homologous with the "proximal median plate" of Neoptera. The third axillary (3) in Paleoptera (observed so far only in Recent orders) lies close to the PNP, so that the tergal series is more or less straight. In Neoptera the third axillary (3) separated from the PNP and was placed in a pivotal position so that the series became typically V-shaped. *Alar pteralia* originated from sclerotized veinal bases, the basivenales. The basicostale (C) has been homologized before (as the humeral plate). Sc, R, M, Cu, A, basivenales compose the basivenal (axillary) plate of Odonata; Sc, R, M basivenales, the basivenal (median) plate of Ephemeroptera, while the enlarged basicubitale stays separate, followed by the small basianale. In Neoptera, basivenales are smaller and fuse occasionally into a "distal median plate." The neopterous V-shaped hinge supposedly was derived from the straight paleopterous hinge demonstrated here, through the third axillary attaining the pivotal position. The lines between pteralia on B. signify: one line — rare articulation, two lines — frequent articulation. Paired apodemal pits (ap) lay mesally from median lobe (me). Specimen PE 16138, Field Museum, Chicago, and specimen 2, coll. Carr, Univ. of Illinois, Urbana. Homiopteridae, Palaeodictyoptera; Upper Carboniferous, Illinois. Original, reconstructed from two specimens.



## PLATE 13

## EXPLANATION OF FIGURES

46 Major steps in pterygote evolution, sponsored by the development of juvenile wings: Pterygota were derived monophyletically from Apterygota through acquiring a paleopterous type of pro-wings on all nymphal body segments (A). In the paleopterous lineage, the meso/metathoracic wings in nymphs increased in size and became curved backwards (a), or flexed backwards (a') along the fold distal to the hinge line. In the neopteran lineage, which originated monophyletically from the early paleopteran stock by developing a pivoting third axillary, the nymphal meso/metathoracic wings became streamlined by actively flexing backwards (b) along the fold within the hinge line. In both Paleoptera and Neoptera, the prothoracic and abdominal wings became more or less reduced. The endopterygote lineage probably originated monophyletically from the juvenile plecopteroid Protorthoptera through the withdrawal of deemphasized wings (b') into subcuticular pockets. Towards the Recent, in all (a, b, and b') lineages juvenile wings independently and parallelly decreased in size and/or became fused with the terga, and as a consequence developed a metamorphic instar. Evolution in adults (B): Outspread pro-wings in paleopterous ancestral pterygotes were flapping and were in elastic equilibrium for effortless soaring. In the paleopteran-lineage, flapping forward flight occurred first (c). In the neopteran lineage elastic equilibrium was lost due to wing flexing (d) and indirect flight musculature became involved in flight (d, d'). Towards the Recent, the wings often tended to become smaller and the wing beat frequency increased by auxiliary structures. Hypothetical early Pterygota: A. older nymph; B. adult. Examples of typical Paleozoic insects: a. Megasecoptera, nymph; b. Protorthoptera, nymph; c. Megasecoptera, adult; d. Protorthoptera, adult. Original.

R E C E N T

U . P A L E O Z O I C

A N C E S T R A L  
P T E R Y G O T A

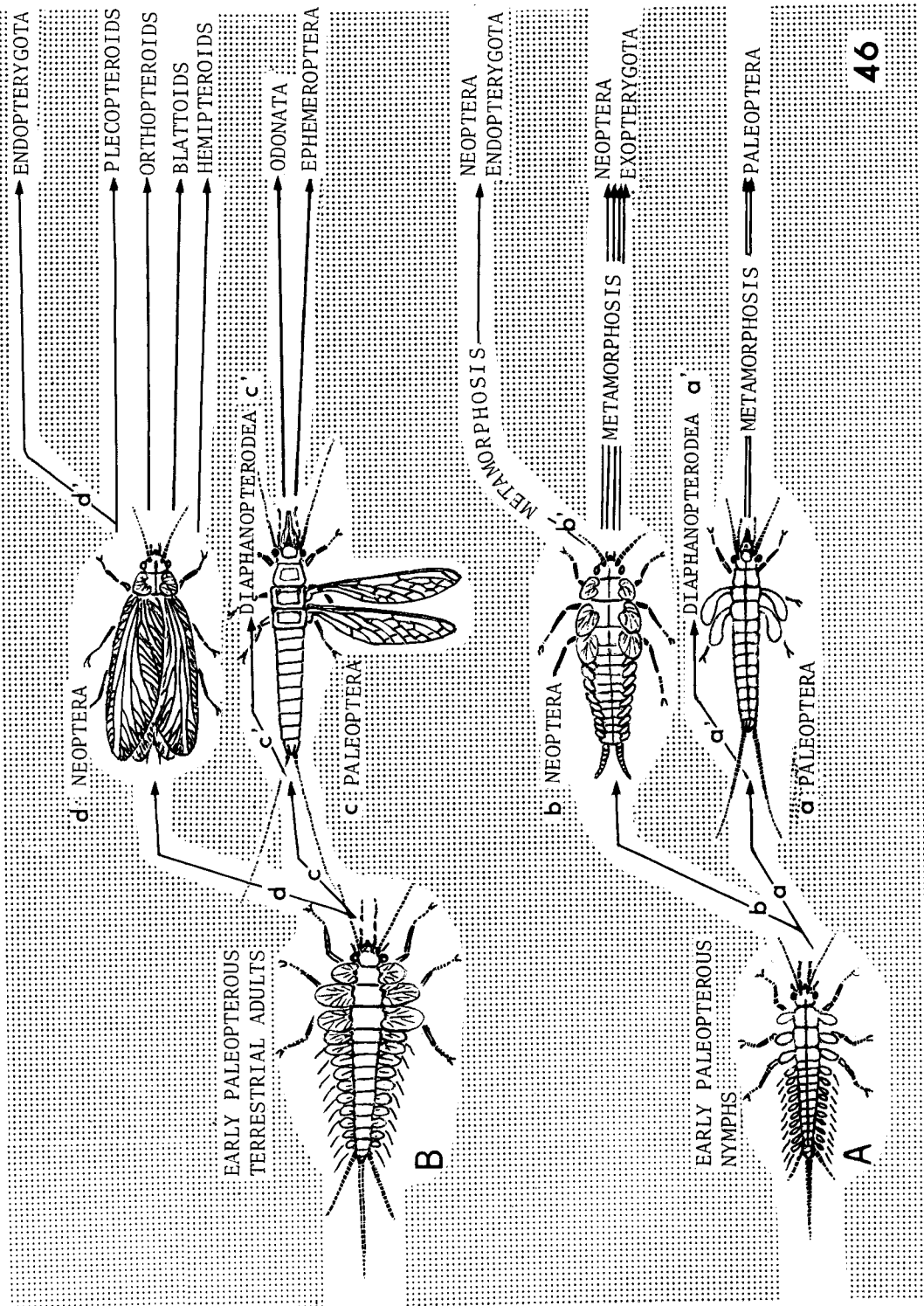

PLATE 14

EXPLANATION OF FIGURES

- 47 Primitive neopteran nymph with wings occurring on three thoracic and ten abdominal segments (also fig. 35). Specimen 8592 ab, Museum of Comp. Zoology, Harvard Univ., Protorthoptera; total length 8 mm; Lower Permian, Kansas. Thoracic wings marked by three short arrows (wing outlines slightly retouched); abdominal wings, by a long arrow.
- 48 Fossil neopterous nymphal wing showing articulation to, not fusion with, the tergum, as opposed to the condition found in all modern nymphs. Free posterior wing margin is marked by two long arrows, free lateral margin of the tergum (showing through the superimposed wing), by a short arrow. Specimen 15789, fore wing. Peabody Museum, Yale Univ., Protorthoptera; wing length 8.7 mm; Lower Permian, Kansas.



