

MAYFLIES (EPHEMEROPTERA) FROM VARIOUS
REGIONS OF SOUTHEAST ASIA

Masuzo Ueno

Minami-Sakurazuka 2-3-13, Toyonaka-shi 560, Japan

ABSTRACT. Nineteen species of Ephemeroptera from various regions of Southeast Asia are treated. One new genus, *Chiusanophlebia* (family Leptophlebiidae) is described from Ryukyu Islands. Three new species, viz., *C. asahinai*, *Baetis sacshimensis* (Ryukyu Island) and *Ephemerella siamensis* (Thailand) are also described.

The present report deals with the mayflies, which were collected in various regions of Southeast Asia by the entomologists sent under the Japan—U. S. Co-operative Science Program. The area of their surveys extended over the subtropical and tropical parts of the western Pacific, covering the Ryukyu Islands and Taiwan in the insular part and some places as far south as Thailand in the continental part. In the former, the collections were made in four islands, Amami-Oshima in the north and the two small islands of Sakishima-Rettô in the south through Okinawa-Jima lying between them. All these districts belong to the Oriental Region zoo-geographically.

All the collections consist of dried specimens, except one *Ephemerella* in alcohol from Okinawa-Jima. No nymphs are contained. In addition to these, a number of mayflies collected in Taiwan in 1961 by Dr. T. Shirôzu of the Kyushu University and offered to the writer are also described in the present report. Both the collectors and the regions where mayflies were collected are listed below.

<i>egion</i>	<i>Name of collector</i>	<i>Year of collection</i>
Ryukyu Islands		
Amami-Oshima.....	S. Asahina	1959
	Y. Miyatake	1963
Okinawa-Jima.....	S. Asahina	1963, 1965
	Y. Miyatake	1964
	K. Morimoto	1965
Sakishima-Rettô :		
Ishigaki-Jima.....	S. Asahina	1962
	Y. Hirashima	1963
	G. A. Samuelson	1963
Iriomote-Jima.....	Y. Hirashima	1963
	Y. Miyatake	1964
Taiwan (Formosa).....	S. Asahina	1964
Hong Kong.....	S. Asahina	1964
Thailand.....	S. Asahina	1965
	Y. Miyatake	1965

List of Species Systematically arranged

	<i>Region</i>
1. Family Siphonuridae	
1. <i>Dipteromimus tipuliformis</i> McLachlan	Amami-Oshima
2. Family Baetidae	
2. <i>Baetis sacishimensis</i> , sp. nov.	Iriomote-Jima, Ishigaki-Jima
3. <i>Baetis</i> sp. (No. 1)	Ishigaki-Jima
4. <i>Baetis</i> sp. (No. 2, new species?)	Iriomote-Jima
5. <i>Baetis</i> sp. (No. 3)	Okinawa-Jima
6. <i>Baetiella japonica</i> (Imanishi)	Taiwan
7. <i>Cloeon marginale</i> Hagen	Okinawa-Jima, Thailand
8. <i>Cloeon bimaculatum</i> Eaton	Iriomote-Jima, Ishigaki-Jima
3. Family Heptageniidae	
9. <i>Rhithrogena parva</i> (Ulmer)	Ishigaki-Jima, Taiwan
10. <i>Ecdyonurus hyalinus</i> (Ulmer)	Okinawa-Jima
11. <i>Ecdyonurus</i> sp.	Okinawa-Jima
12. <i>Paegniodes cupulatus</i> (Eaton)	Hong Kong
4. Family Leptophlebiidae	
13. <i>Chiusanophlebia asahinai</i> , gen et sp. nov.	Amami-Oshima, Okinawa-Jima and Ishigaki-Jima
5. Family Potamanthidae	
14. <i>Potamanthodes formosus</i> (Eaton)	Taiwan
6. Family Ephemeridae	
15. <i>Ephemera javana</i> Navás	Thailand
16. <i>Ephemera formosana</i> Ulmer	Okinawa-Jima, Ishigaki-Jima, and Taiwan
17. <i>Ephemera purpurata</i> Ulmer	Thailand
18. <i>Ephemera siamensis</i> , sp. nov.	Thailand
19. <i>Ephemera sauteri</i> Ulmer	Taiwan

FAMILY SIPHLONURIDAE

1. *Dipteromimus tipuliformis* McLachlan

Dipteromimus tipuliformis: Eaton, 1888, *Trans. Linn. Soc. London, Zool.*, (3) 2: 213;
Uéno, 1931, *Annot. Zool. Japon.*, 13: 212, with description of nymph.

Specimen examined: 1♂, Iwakodake, Amami-Oshima, 16.vii.1963, Y. Miyatake leg.

Since this species has been known only from Japan north of Kyushu, it is worthy of note that its distribution extends as far to the south as the Island of Amami-Oshima, north of Okinawa-Jima in the Ryukyu Islands.

FAMILY BAETIDAE

2. *Baetis sacishimensis*, sp. nov. (Figs. 1-7)

Length: Body 3.5 mm, fore wing 5 mm.

Wings entirely hyaline, with tip broadly rounded, intercalaries in pairs. Hind wing with an acute costal projection of brown colour near base, with two longitudinal veins ending in wing tip, hind one forked at about three-fifths from base, one marginal intercalary present between forked branches. Head and thorax blackish; basal joints of antenna blackish-brown, bristle pale yellow. Turbinate eyes well developed. Legs brownish-yellow; fore leg, tibia 1.5 times as long as femur which is a little longer than tibia. Tarsal joints from longest to shortest: 2, 3, 4, 1. Abdominal segments II-VII hyaline, I, VIII and IX tergites blackish-brown. Forceps 4-jointed, the last joint small and papilla-like.

Holotype ♂, Iriomote-Jima, 9.iii.1964, Y. Miyatake leg. *Paratype* 1 ♂ (?), Ishigaki-Jima, Mt. Omoto, 200 m, 17-20.x.1963, G. A. Samuelson leg.

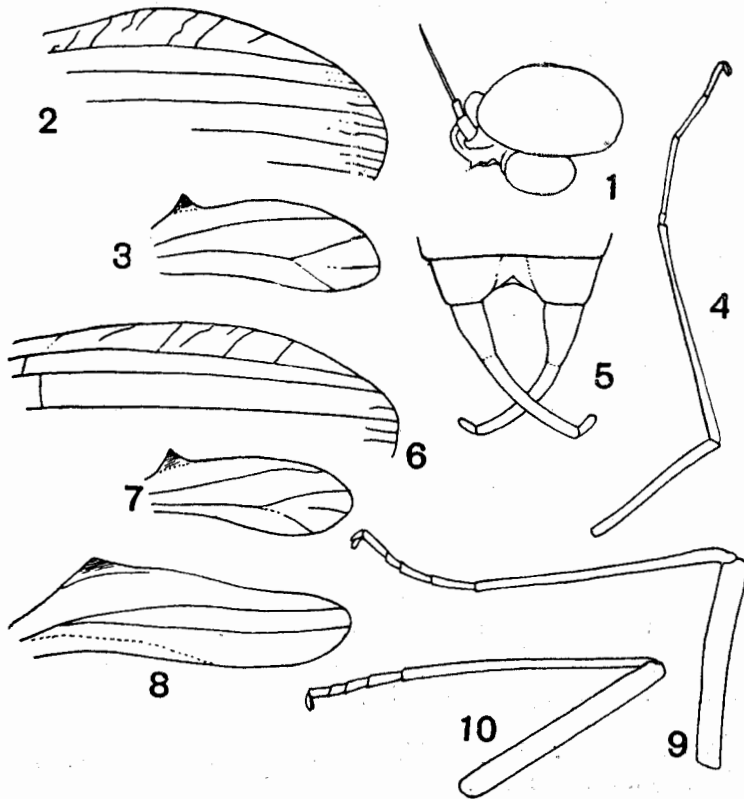

Figs. 1-7, *Baetis sacishimensis*, sp. nov. [from Iriomote-Jima: 1, ♂ head, lateral view; 2, apical part of fore wing; 3, hind wing; 4, ♂ fore-leg; 5, forceps. 6, 7, the same species from Ishigaki-Jima: 6, fore wing; 7, hind wing. 8-10, *Baetis* sp. (No. 1) from Iriomote-Jima: 8, hind wing; 9, ♀ fore leg; 10, ♀ hind leg.

The present species differs from the known species in the bifurcation point (three-fifths from the base) of the second longitudinal vein in the hind wing. In most of the species with such a vein the fork occurs either near the base (e.g., North American *B. parvus* Dodds) or in about the middle (e.g., European *B. niger* Linné).

Distribution : Ryukyu Islands.

3. *Baetis* sp. (No. 1) (Figs. 8-10)

Specimen examined : 1 ♀, Iriomote-Jima, 9.iii.1964, Y. Miyatake leg.

Body length 4 mm. Hind wing with a costal projection less prominent than in *B. sacishimensis* ; with two longitudinal veins, the second not forked, running side by side and ending in wing-tip ; a trace of the third longitudinal vein extending to the middle of hind margin. Legs yellow, without dark parts. Abdominal tergites reddish-brown, sternites reddish-yellow. The identification is impossible, as there is only one ♀ in an inadequate state of preservation.

Distribution : Ryukyu Islands.

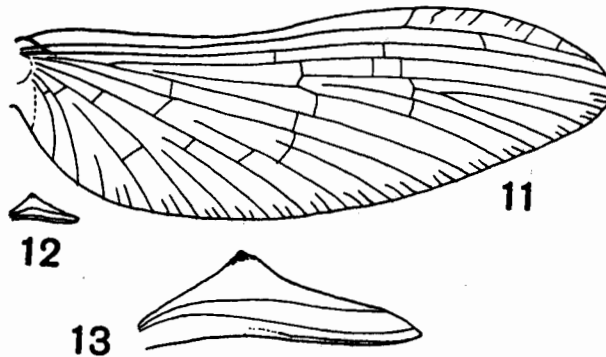

Figs. 11-13. *Baetis* sp. (No. 2, new species ?) : 11, fore wing ; 12, hind wing ; 13, hind wing, enlarged.

4. *Baetis* sp. (No. 2, new species ?) (Figs. 11-13)

Specimen examined : 1 ♀, Shirahama, Iriomote-Jima, 4.x.1963, Y. Hirashima leg., by a Malaise trap.

Body length 3.5 mm, fore-wing 4 mm. Wings hyaline, venation very delicate, with several cross-veins in the stigmatic area, intercalaries in pairs. Hind wings very small, about one-ninth as long as fore wing, narrow, with a broadly triangular costal projection ; with two longitudinal veins and one more incomplete vein close to hind margin. Specific determination is impossible, as

there is only one female specimen, but from the feature of the hind wing it may be inferred as a new species.

Distribution : Ryukyu Islands.

5. *Baetis* sp. (No. 3)

Specimen examined : 1 ♂ subimago, Yonabaru, Okinawa-Jima, 22.v.1965, K. Morimoto leg.

Distribution : Ryukyu Islands.

6. *Baetiella japonica* (Imanishi) (Figs. 14-19)

Acentrella japonica Imanishi, 1930, *Trans. Nat. Hist. Soc. Formosa*, 20 : 263, figs. 1-2.

Baetiella japonica : Uéno, 1931, *Annot. Zool. Japon.*, 13 : 220, figs. 30-31, with description of nymph.

Specimens examined : 1 ♂, 2 ♂♂ (?) (body partly lost), 1 ♀ (?), Taiwan, Mt. Arisan, at 2,200 m, 11.vii.1964, S. Asahina leg.

Fore wing 6.5-7.0 mm, hyaline, narrow, long for its width, but not so remarkably long as in the Japanese specimens (cf. Imanishi, 1930, fig. 1 ; Uéno, 1931, fig. 30) ; the ratio, length : maximum breadth = 3.5 : 1 in the Japanese specimens, whereas it is 3 : 1 in the Taiwan forms. The venation agrees well with that of Imanishi's original description ; intercalaries on outer margin arranged in pairs. Hind wings absent.

Thorax black above and sides. Legs pale yellow. Fore legs, the last joint of tarsus and tarsal claws black. Caudal filaments pale yellow, with black joinings. Male fore leg long and slender, tarsus as long as tibia which is about twice the length of femur, tarsal joints from longest to shortest : 2, 3, 4, 5, 1 ; claws dissimilar. The relative length of both tarsus and tibia is somewhat different from that of the Japanese forms, in which tarsus is about three-fourths as long as tibia (cf. Bruggen, 1960, p. 16, fig. 4). Hind tarsus half the length of tibia in ♀ as in the Japanese specimens (cf. Bruggen, l.c., p. 18, Table 1), but it is somewhat shorter in ♂ ; the first tarsal joint fused with tibia, which is 2.5 times as long as tarsus.

Baetiella is one of the six known baetine genera, in which hind wings are completely absent and fore wings have paired intercalaries on hind margin. The nymph of *B. japonica* is always found in rapid mountain streams. The present record proves that its distribution ranges not only in the Palaearctic but also in the Oriental Region. It is also of interest that it was taken at a place as high as 2,200 m above sea level in central Taiwan.

Distribution : Taiwan, Japan.

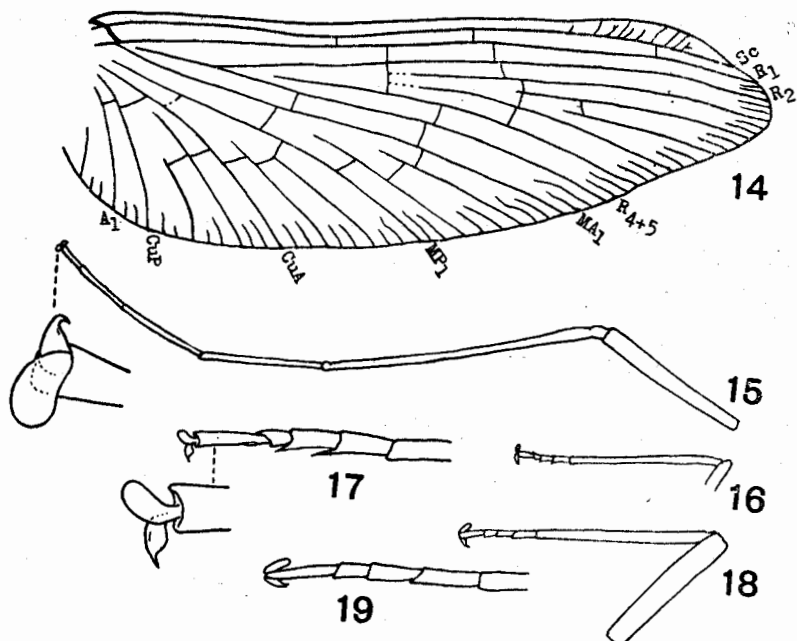

Figs. 14-19. *Baetiella japonica* (Imanishi): 14, ♀ fore wing; 15, ♂ fore leg; 16, 17, the same, tarsus and claws; 18, ♂ hind leg, 19, the same, tarsus.

7. *Cloeon marginale* Hagen

Specimens examined: 1 ♂, 1 ♀, Songkhla, South Thailand, facing the Gulf of Siam, 22.vi.1965, Y. Miyatake leg.; 2 ♀♀, Yonabaru, Okinawa-Jima, 22.iii.1964, Y. Miyatake leg.

Length: Songkhla specimens, body 4 mm in both sexes, fore wing 4 mm in ♂, 4.5 mm in ♀; Okinawa-Jima specimens, body 5-6 mm forewing 6-6.5 mm.

Wings hyaline, no cross-veins before bulla, costal margin in ♀ tinged with brown. Male: thorax chestnut-brown above, pale below; abdominal tergites I, IX and X brown, II-VIII pale, with dark markings; sternites without markings. Female: head brown, thorax ochreous, abdomen reddish-brown above, ochreous below. Fore legs brownish yellow, mid and hind legs yellow. Caudal filaments pale.

Distribution: Taiwan (Ulmer, 1912, 1931), Tonkin, Canton, the Philippines, Java, Sumatra, Bengal, Ceylon and Thailand (Uéno, 1961), Ryukyu Islands.

8. *Cloeon bimaculatum* Eaton

Specimens examined: 3 ♂♂, 1 ♀, Iriomote-Jima, 5.iii.1964, Y. Miyatake leg., at light; 1 ♂, 2 ♀♀, Banna, Ishigaki-Jima, 16.x.1963, Y. Hirashima leg., by a light trap.

Length of the specimens from Ishigaki-Jima : body 4.5 mm in ♂, 5 mm in ♀, fore wing 4.5 mm in ♂, 5 mm in ♀. Wings hyaline, with several cross-veins in the stigmatic area, costal margin in ♀ tinged with amber color.

Distribution : Java, Sumatra, Bengal, Thailand (Uéno, 1961), Tonkin, Ryukyu Islands.

FAMILY HEPTAGENIIDAE

9. *Rhithrogena parva* (Ulmer) (Figs. 20-25)

Ecdyurus parvus Ulmer, 1912, *Ent. Mitt.*, 1 : 374, figs. 9-10.

Rhithrogena parva : Ulmer, 1939, *Arch. Hydrobiol.* (Suppl. Bd.) 16 : 574.

Specimen examined : 1 ♀, Tokuyama, Ishigaki-Jima, 15.vi.1962. S. Asahina leg.

Smaller than the type specimens ; body 5 mm, fore wing 8 mm, caudal filaments partly lost. Head brown, compound eyes and ocelli black. Thorax brown. Fore legs brown, mid legs yellowish-brown, and hind legs yellow. Caudal filaments pale yellow. Fore tarsal joints, 1 as long as 2, 3 and 5 subequal, 4 the shortest. Fore tibia a little longer than fore tarsus, claws dissimilar. Hind tarsal joints from longest to shortest : 5, 1, 2, 4, 3. Fore wings hyaline, costal margin tinged with yellow, with many cross-veins, partly thickened. Hind wings : unbranched radius very small. Markings on abdominal tergites some-

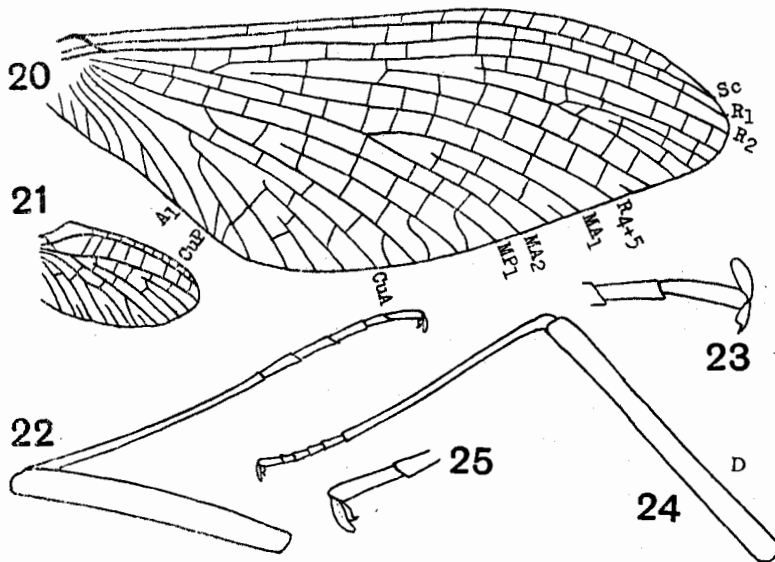

Figs. 20-25. *Rhithrogena parva* (Ulmer) ♀ : 20, fore wing ; 21, hind wing ; 22, fore leg, 23, the same, claws ; 24, hind leg, 25, the same, claws.

what resemble those of *Afronurus javanicus* Ulmer (1939, p. 560, fig. 134); chestnut-brown, with dark markings on both sides of I-IX, a pair of indistinct stripes on VIII and IX.

Distribution : Taiwan, Ryukyu Islands.

10. *Ecdyonurus hyalinus* (Ulmer)

Ecdyonurus hyalinus Ulmer, 1912, *Ent. Mitt.*, 1 : 372, figs. 4-7.

Specimens examined : 1 ♀, Yonabaru, Okinawa-Jima, 24.iii.1964, Y. Miyatake leg. ; 1 (sex ?, defective specimen) from the same locality and date, Miyatake leg.

Body 8 mm, fore wing 10 mm, caudal filaments lost.

Wings hyaline with faint yellow tinge, costal margin tinged with amber-yellow. Fore leg : femur and distal half of tibia brown, tarsus yellow. Hind tarsus shorter than half of tibia, joint 1 a little longer than joint 2, order from longest to shortest : 1, 5, 2, 3, 4. Abdomen reddish-brown, sternites reddish-yellow.

Distribution : Ryukyu Islands.

11. *Ecdyonurus* sp.

Specimen examined : 1 ♀ subimago, Yonabaru, Okinawa-Jima, 25.iii.1964, Y. Miyatake leg.

Distribution : Ryukyu Islands.

12. *Paegniodes cupulatus* (Eaton) (Figs. 26-36)

Heptagenia cupulata Eaton, 1871, *Trans. Ent. Soc. London*, p. 138, figs. 14, 14a.

Paegniodes cupulatus : Eaton, 1885, *Trans. Linn. Soc. London, Zool.*, (3) 2 : 261, t. 23, fig. 41, tab. 24, fig. 41 ; Ulmer, 1926, *Arch. Naturgesch.*, A 91 (5) : 107, figs. 98-102.

Specimens examined : 1 ♂, Pak Ngnau Shek, N. T. (Hong Kong), 24.vii.1964, S. Asahina leg. ; 1 ♂, Taipokau, Hong Kong, 27.vii.1964, S. Asahina leg.

Pak Ngnau Shek ♂ : body 13 mm, fore wing 10.5 mm ; Taipokau ♂ : fore wing 9.5 mm ; caudal filaments of the former specimen nearly three times as long as body, about 35 mm long, middle one completely reduced. Fore wings faint brown infuscate, iridescent, costal margin tinged with amber color, without patterns, with four cross-veins between A_1 and hind margin. Hind wings small, brownish infuscated, costal margin amber color, outer margin with a very wide brown border. Head brown, eyes black. Prothorax brown, mesothorax brownish-ochreous. Abdominal tergites reddish, sternites brownish-ochreous. Fore leg brown, becoming pale toward distal end, last tarsal joint and claws blackish. Mid and hind legs brownish-yellow. Fore leg : tibia a

little longer than femur, three-fifths as long as tarsus, tarsal joints from longest to shortest : 2, 3, 4, 1, 5 ; 1 and 5 subequal, claws dissimilar. Hind leg : tibia shorter than femur, tarsus three-fourths as long as tibia, tarsal joints : 2, 1, 3, 5, 4 ; claws dissimilar. Abdominal segments I-VII semi-transparent, each tergite ochreous-yellow on both sides, with dark red oblique stripes which become broad on posterior tergites, VIII-X opaque, dark red, with a pair of yellow median longitudinal stripes. Sternites yellow, VII-IX opaque and ochreous. Tenth sternite : hind margin convex at middle, both sides of which are emarginate, separating, with projecting lateral parts to which

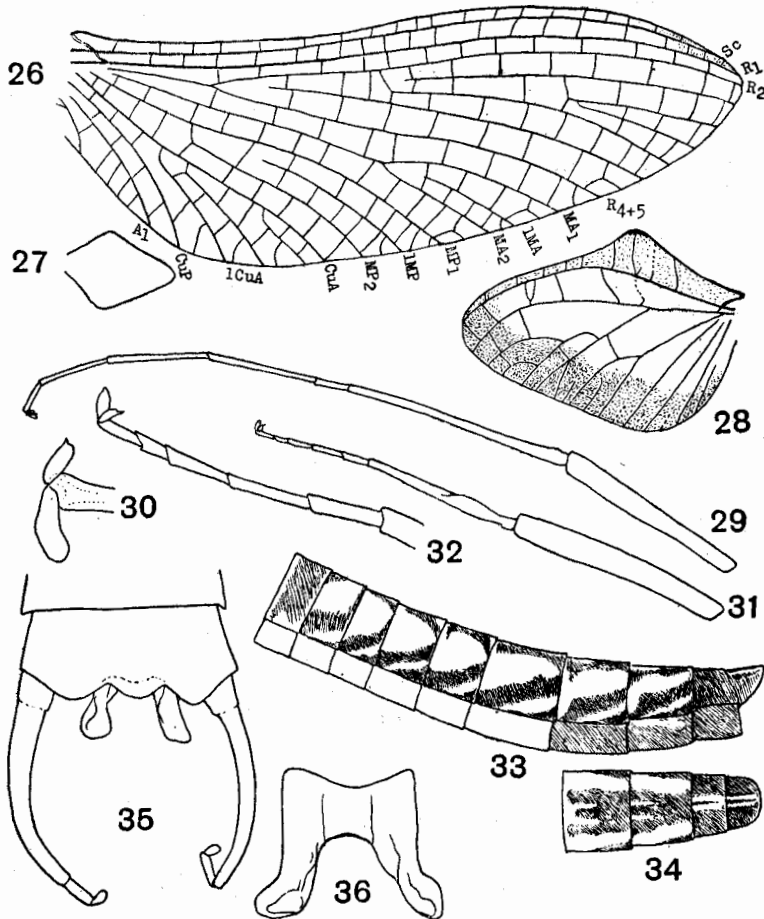

Figs. 26-36. *Paegniodes cupulatus* (Eaton): 26, fore wing; 27, hind wing; 28, hind wing, enlarged; 29, ♂ fore leg, 30, the same, claws; 31, ♂ hind leg, 32, the same, tarsus and claws; 33, abdomen, left side; 34, the same, the last four tergites, dorsal view; 35, forceps, ventral view; 36, penial lobes.

bases of forceps are attached. Forceps brown, 4-jointed, the second joint long and curved, the third and the fourth joints together much shorter than the second. Penial lobes widely separated from each other, cylindrical, somewhat bent outward at their club-form apices.

The length ratio of leg joints is somewhat different from Ulmer's description (Ulmer, 1926, p. 108). In the fore tarsal joints in Ulmer's male specimens, 3 subequal to 2, and 1 subequal to 5, whereas 2, 3, 4, 5, 1 in the present male from longest to shortest; 2 slightly longer than 3, and, 1 and 5 subequal. The tarsal joints of the hind leg in Ulmer's specimens are 2, 3, 1, 5, 4, while they are 2, 1, 3, 5, 4 in the present specimens. The tenth tergite is reddish with median light stripes, but it is brownish-ochreous in Ulmer's specimens.

Distribution : Southern China, Tibet, Hong Kong.

FAMILY LEPTOPHLEBIIDAE

Chiusanophlebia, gen. nov.

Blackish-brown mayfly of medium size. Fore wing : MA₁ and MA₂ symmetric, none of costal cross-veins present before bulla. Hind wing completely absent. Fore leg, with 5 tarsal joints and dissimilar claws. Mid and hind legs, with 4 tarsal joints and dissimilar claws. Last sternite not divided. Forceps 2-jointed, distal joint very small. Penial lobes tubular, parallel, not modified at apices.

Type-species : *Chiusanophlebia asahinai*, sp. nov.

Distribution : Ryukyu Islands.

The present new genus resembles both *Dipterophlebiodes* Demoulin (type-species : *D. sarawacensis* Demoulin, 1954) from Borneo and *Nathanella* Demoulin (type-species : *N. indica* Demoulin, 1955) from India, in regard to the characteristics of venation and the complete reduction of hind wings. It is more like the latter genus than the former. The wing is broadest at the distal half in the former, but at the basal half in the latter and the present new genus. Both branches of MA are symmetric in the latter two genera, but in *Dipterophlebiodes* they are somewhat asymmetric. The present new genus has no cross-veins between C and Sc before bulla. The penial lobes are bent outward at their apices in *Dipterophlebiodes*, but *Nathanella* and *Chiusanophlebia* have the straight and parallel penial lobes, though their apices are somewhat different from each other.

At least five genera without hind wings are known in the family Leptophlebiidae (cf. Peters & Edmunds, Jr., 1964), viz., *Fullea* Navás, *Hagenulodes* Ulmer, *Hagenulopsis* Ulmer, *Dipterophlebiodes* Demoulin and *Nathanella* Demoulin. Among these, except the first two Ethiopian genera, the Neotropical *Hagenulopsis* and the remaining two, *Dipterophlebiodes* and *Nathanella*, are restricted to the Oriental Region. *Chiusanophlebia* may be regarded as the third genus occurring in the Far Eastern part of the last named Region.

13. *Chiusanophlebia asahinai*, sp. nov. (Figs. 37-44)

Length : Body 6.5 mm, fore wing 6 mm, caudal filaments ca. 11 mm.

Head and thorax blackish-brown; turbinate eye well developed; antennae brown. Fore leg : femur blackish-brown, tibia and tarsus grey. Mid and hind legs: femora blackish, tibiae and tarsi grey. Fore tarsus nearly as long as fore tibia, tarsal joints from longest to shortest: 2, 3, 4, 5, 1, with dissimilar claws. Hind tarsus about one-third the length of tibia, which is a little longer than or as long as hind femur, with four movable joints, from longest to shortest: 4, 1, 2, 3, with dissimilar claws. Fore wing narrow, three times as long as broad, faintly greyish, subcostal area faint yellow, no cross-veins before bulla, MA forked at three-fifths from base. Hind wings completely absent. Tergites and sternites of abdomen blackish-brown, with indistinct black markings which are a pair of longitudinal striae on III-VI; last sternite not divided. Three caudal filaments. Forceps 2-jointed, grey in color, the first joint with broad basal part and becoming slender distally, the second joint small and knob-like form. Penial lobes tubular, parallel to each other, not modified at apices.

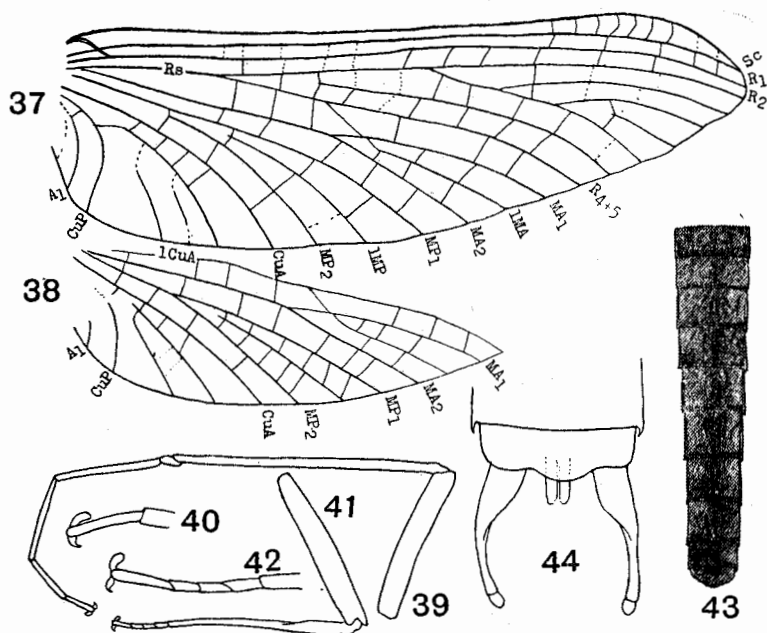

Figs. 37-44. *Chiusanophlebia asahinai*, gen. et sp. nov. 37, fore wing of the specimen from Okinawa-Jima ; 38, proximal part of fore wing of the holotype from Amami-Oshima ; 39, ♂ fore leg, 40, the same, claws ; 41, ♂ hind leg ; 42, the same, tarsus and claws ; 43, abdomen, dorsal view ; 44, forceps, ventral view.

Holotype ♂, Yuwan-Ishara, 12.vii.1959, S. Asahina leg.; 1♂, Yonabaru, Okinawa-Jima, 28.v.1963, S. Asahina leg. *Paratype* 1 (sex?) defective specimen, Ishigaki-Jima, Mt. Omoto, at 200 m above sea level, 17.x.1963, G. A. Samuelson leg.

FAMILY POTAMANTHIDAE

14. *Potamanthodes formosus* (Eaton) (Figs. 45-52)

Potamanthus formosus Eaton, 1892, *Trans. Ent. Soc. London*, p. 186; Ulmer, 1920, *Arch. Naturgesch.*, 1919 (1920): 11, fig. 8; Ulmer, 1926, *Arch. Naturgesch.*, (A) 91 (5): 98, figs. 86-88.

Potamanthus (Potamanthodes) kamonis Imanishi, 1940, *Rep. Limnol. Surv. Kwantung & Manchoukuo*, p. 178, fig. 1.

Specimens examined: 6 ♂♂, 40 ♀♀, 11 subimagines, Urai, northwest of Taihoku in Taiwan, 7.vii.1961, T. Shirozu leg. at light.

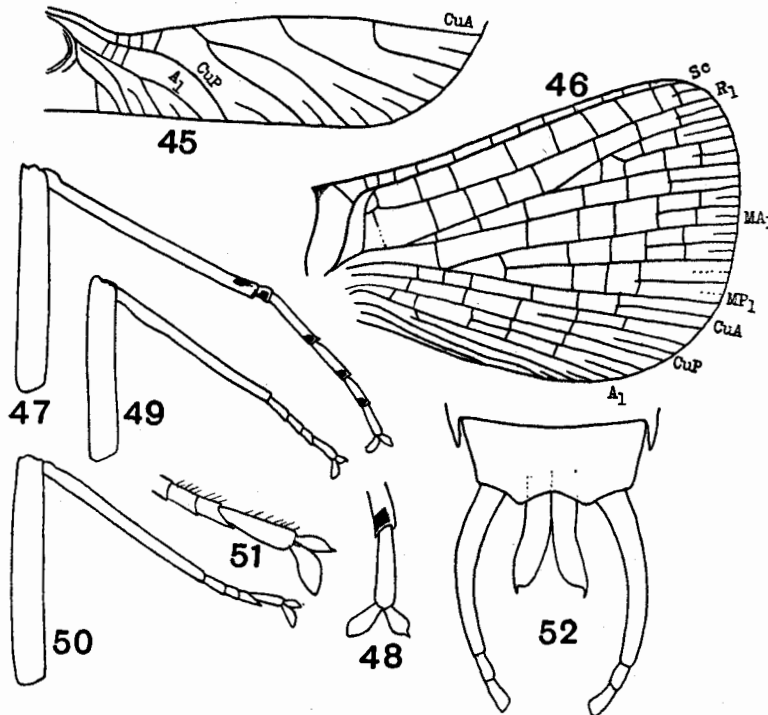

Figs. 45-52. *Potamanthodes formosus* (Eaton): 45, Cubito-anal part of fore wing; 46, hind wing; 47, ♂ fore leg, 48, the same, claws; 49, ♂ mid leg; 50, ♂ hind leg; 51, the same, claws; 52, forceps and penial lobes.

This is one of the commonest mayflies in Taiwan. Body length is 10-12 mm in ♂ and ♀, fore wing 9-10 mm, caudal filaments 13-14 mm in ♀ and ca. 25 mm in ♂.

Imanishi (1940, p. 178) recognized *Potamanthodes* as a subgenus of *Potamanthus*, under which he described a new species *P. (P.) kamonis* Imanishi from Japan. He indicates that the penial lobes of *P. (P.) kamonis* are about half as long as the first joint of the forceps (cf. Ulmer's figure, 1926, p. 88). In the Urai specimens in question, the penial lobes are variable in length, mostly extending a little beyond the half of the first joint of forceps, as in *P. kamonis*. The penial lobes of *P. kamonis* entirely agree in shape with those of *P. formosus*. Body and fore wings are a little longer in *P. formosus* than in *P. kamonis*. The male fore tarsus of the Urai specimens has a blackish-brown marking on the distal end of each joint, except the last, as well as on the distal end of tibia, as Imanishi pointed out in *P. kamonis*.

Potamanthus (Potamanthodes) kamonis Imanishi should be identical with *Potamanthodes formosus*. The range of its distribution extends from Taiwan northward to Japan, where it was first collected by H. Sauter as far back as 1904 on Mt. Otakisan, in the province of Mimasaka (the present-day Okayama Prefecture).

FAMILY EPHEMERIDAE

15. *Ephemera javana* Navás (Figs. 53-58)

Specimen examined : 1♂, Mae Sa Waterfall, North Thailand, 16.vi.1965, S. Asahina leg., at light.

Length : Body 11 mm, fore wing 10 mm, caudal filaments 23 mm.

Wings hyaline, faintly amber-brown infuscate when both fore wings lie upon each other, costal margin tinged with amber-brown, shadowed brownish around costal cross-veins of basal half. Several brown patterns present at middle and some other parts of wings. MP_2 of fore wing connected with CuA near base, as Ulmer (1939, p. 476) pointed out. Fore legs brown, mid and hind legs yellow, coxa of hind leg with a blackish-brown spot. Caudal filaments brown. Abdomen reddish-brown with black striations on tergites and sternites III-IX, as shown in figure 8; on anterior half of sternite I there is present a faint reddish-brown marking in horse-shoe shape.

Distribution : Java (900 m above the sea), Sumatra, Thailand.

16. *Ephemera formosana* Ulmer

Specimens examined : 1♀, Barubido, Ishigaki-Jima, 7.vi.1962, S. Asahina leg.; 1♂, Yonabaru, Okinawa-Jima, 28.v.1963, S. Asahina leg., 1♂ from the same locality, 21.v.1965, S. Asahina leg. (in alcohol), 3♂♂ from the same, 21 and 22.v.1965, K. Morimoto leg.; 3♂♂, 3♀♀, Urai, North Taiwan, 7.vii.1961, T. Shirozu leg.

Length : Body 13-16 mm, fore-wing 14-15 mm, caudal filaments 34-38 mm.

Distribution : Ryukyu Islands, Taiwan.

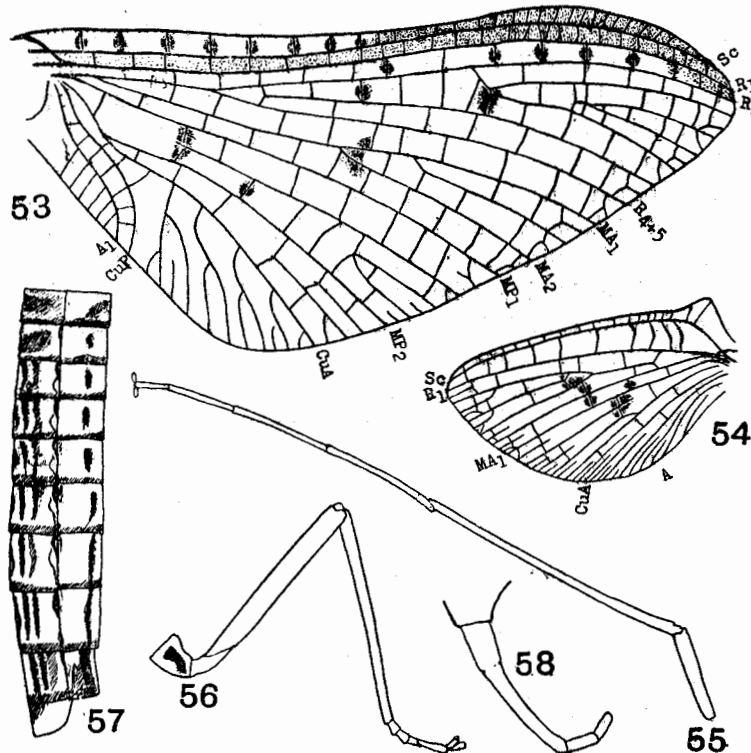

Figs. 53-58. *Ephemera javana* Navás; 53, fore wing; 54, hind wing; 55, ♂ fore leg; 56, ♂ hind leg; 57, abdomen, right side; 58, forceps.

17. *Ephemera purpurata* Ulmer (Figs. 59, 60)

Specimens examined : 1 ♀, Fang (Muang Fang), northernmost part of Thailand, 14.vi.1965, Y. Miyatake leg.; 1 ♀, from the same locality, 14.vi.1965, S. Asahina leg.

Length : Body 13 mm, fore wing 13 mm, caudal filaments 15 mm.

Wings hyaline, subcostal area faintly amber-brown, venation brown, cross-veins between C and Sc as well as other main cross-veins reddish-brown. Head and thorax yellowish-ochreous, abdomen ochreous. Fore leg brown, mid and hind legs yellowish-ochreous, with a coxal black spot on hind-leg, and with black tarsal claws.

Distribution : China, Houy-Théou (Hsu, 1936), Thailand.

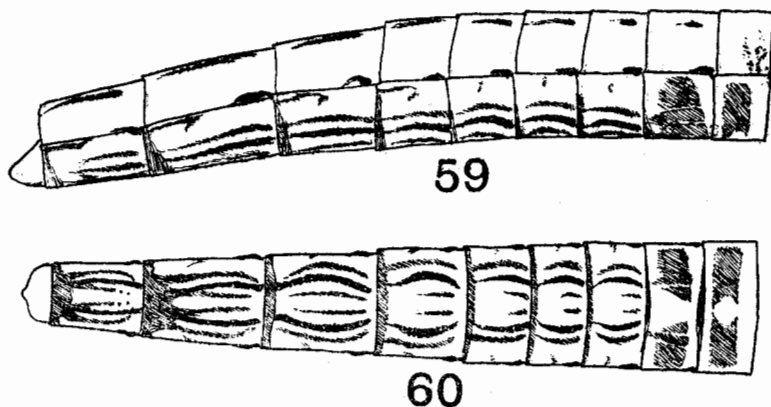

Figs. 59-60. Abdomen of *Ephemera purpurata* Ulmer; 59, left side; 60, dorsal side.

18. *Ephemera siamensis*, sp. nov. (Figs. 61-77)

Length : Body 11 mm, fore wing 10 mm, caudal filament (middle) 21 mm.
Subimago : body 12 mm in ♂ and 11 mm in ♀.

Head chestnut-brown. Compound eyes black. Pronotum chestnut-brown. Mesothorax with blackish sides. Fore leg blackish-brown, mid and hind legs ochreous, with brown femora. Both mid and hind tarsus 4-jointed, claws dissimilar. Wings faint brown infusate, glistening, costal margin dark brown, venation brown, shadowed brownish along main cross-veins. Abdomen dark ochreous, with distinct blackish markings on tergites and sternites. Tergites II-VII with a pair of black markings convergent posteriorly; they are small patches in anterior tergites and becoming conspicuously large in hinder tergites; indistinct four dark broad bands on tergite VIII, those on IX more indistinct, and two dark short markings of X (compare with ♂ subimago given below). Sternites ochreous, III-IX presenting a pair of blackish markings which are divergent posteriorly and gradually become long and parallel to each other from VI, with one more fine stria on outer side of each streak on VIII and IX. Forceps 4-jointed, last two joints together about one-third as long as second and a little shorter than basal. Penial lobes short and rod-like, nearly parallel, and separate widely.

Subimago ♂ : Abdomen whitish-ochreous; tergites III-IX much larger and broader than those of imago ♂, with blackish-brown markings convergent posteriorly. These markings gradually become parallel on VII-X forming four longitudinal striae, of which outer two are broad and inner two fine; on VIII-X they are more distinct than in imago and fused together with hind transverse area on tergite X.

Subimago ♀: Pronotum blackish-brown, mesonotum ochreous with black longitudinal bands. Abdomen ochreous, sternites pale; tergites I-X dark, leaving light areas, such as narrow lateral margins and a longitudinal stria on either side of median line; these striae short and somewhat divergent on III-VI, long and parallel on VII; on tergites VIII-X dark areas appear so as to form four longitudinal striae, as in subimago ♂; they are fused together with hind transverse dark area on VIII and IX. Sternites with a pair of short blackish-brown striae which are somewhat divergent posteriorly on III-V and become parallel on VI-IX.

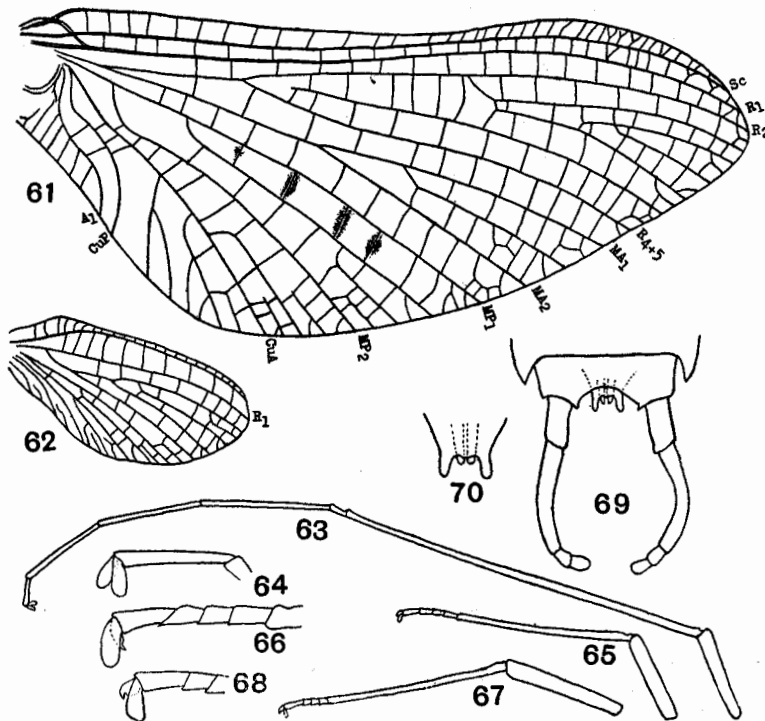

Figs. 61-70. *Ephemera siamensis* sp. nov. (♂): 61, fore wing; 62, hind wing; 63, fore leg; 64, the same, claws; 65, mid leg; 66, the same, tarsus and claws; 67, hind leg; 68, the same, claws; 69, forceps; 70, penial lobes.

Holotype ♂, *Paratypes* 3♂♂, Chiang Mai, Thailand, 10.vi.1965, S. Asahina leg. *Paratypes*: same locality, 3♂♂, 10 & 11.vi.1965, Y. Miyatake leg., 19♂♂, 9♀♀ subimagines, 10 VI 1965, S. Asahina leg., 11♂♂, 4♀♀ subimagines, 10.vi.1965, Y. Miyatake leg.

This species is distinguishable from the known species of the genus *Ephemera* in its distinct black paired markings convergent posteriorly on both tergites and sternites.

Distribution : Thailand.

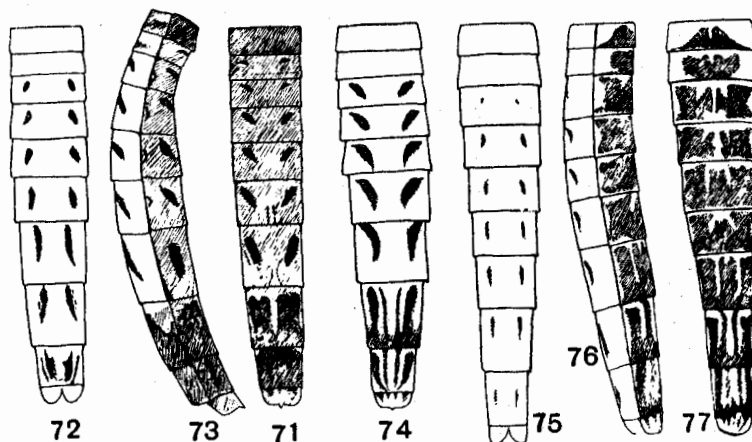

Figs. 71-77. *Ephemera siamensis* sp. nov. : 71-73, ♂ imago (holotype) ; 74, ♂ subimago ; 75-77, ♀ subimago. 71, dorsal; 72, ventral; 73, left side ; 74, dorsal ; 75, ventral; 76, left side ; 77, dorsal.

19. *Ephemera sauteri* Ulmer

Specimen examined : 1 ♂, Taiwan, Mt. Arisan at 2,200 m above sea level, 10.vii.1964, S. Asahina leg.

Length : Body 14 mm, fore wing 14 mm, caudal filaments ca. 35 mm.

Markings on tergites somewhat more distinct than those of the type-specimens.

Distribution : Taiwan and China. Lofau shan, Canton (Hsu, 1936).

SUMMARY

Nineteen species of mayflies, three of which it was impossible to determine, are recorded from various districts of Southeast Asia, viz., the Ryukyu Islands, Taiwan, Hong Kong and Thailand. One new genus is described in the Leptophlebiidae on the basis of the specimens from the first-named region. Three new species belonging to three genera, one of which is a new genus, are also described. All the recorded species but two belong in their geographical distribution to the Oriental Region. It is evident that some austral species extend their range of distribution toward the islands northeast of Taiwan. Two species of the Palearctic distribution, i.e., *Dipteromimus tipuliformis* McLachlan and *Baetiella japonica* (Imanishi), range southward from Japan. The former was found in Amami-Oshima and the latter as far to the south as Taiwan. On the contrary, *Potamanthodes formosus* (Eaton) of Taiwan ranges northward to the southwestern part of Japan.

REFERENCES

- BRUGGEN, A. C. van, 1960. On the generic position of *Cloeon papuanum* van Bruggen, 1957 (Ephemeroptera, Baetidae). *Nova Guinea, Zool.* (N. S.) 5:15-21.
- DEMOULIN, G. 1954. Les éphéméroptères Leptophlebiidae de Borneo. *Bull. Ann. Soc. Ent. Belg.* 90 (V-VI) : 123-131.
- DEMOULIN, G. 1955. *Nathanella* gen. nov., Leptophlebiidae diptère de l'Inde (Ephemeroptera). *Bull. Inst. Roy. Sci. Nat. Belg.* 31 (77) : 1-4.
- EATON, A. E. 1883-1888. A Revisional Monograph of Recent Ephemeridae or Mayflies. *Trans. Linn. Soc. London, Zool.* (3)2:1-352.
- HSU, Yin-chi 1936-37. The mayflies of China. *Peking Nat. Hist. Bull.* 2(2): 129-148; (3): 287-296.
- IMANISHI, K. 1930. Mayflies from Japanese torrents. I. New mayflies of the genera *Acentrella* and *Ameletus*. *Trans. Nat. Hist. Soc. Formosa* 20: 263-267.
- IMANISHI, K. 1940. Mayflies from Manchuria, Inner Mongolia and Korea. *Rep. Limnol. Surv. Kwantung and Manchoukuo*. Dairen, 169-263. (in Japanese).
- LESTAGE, J. A. 1927. Une *Ephemera* nouvelle du Tonkin et tableau des espèces de la faune orientale. *Ann. Soc. Ent. France* 96: 93-100.
- LESTAGE, J. A. 1929. Les *Cloeon* des régions Indo-Malaise et Australienne. *Ann. Soc. Ent. France* 98 : 97-100.
- MCLACHLAN, R. 1904. Neuroptera from Western China. Pseudo-Neuroptera. Fam. Ephemeridae. *Ann. Mag. Nat. Hist.* (6) 13 : 428-429.
- NAVAS, Longin 1936. Névroptères et insectes voisins chine et pay environnants. *Notes d'entomologique chinoise, Musée Heude* 3 (7): 117-125.
- PETERS, W. L. and G. F. Edmunds, Jr. 1964. A revision of the generic classification of the Ethiopian Leptophlebiidae (Ephemeroptera). *Trans. R. Ent. Soc. London* 116 (10) : 225-255.
- UENO, M. 1931. Some notes on the mayfly-fauna of Formosa. *Trans. Nat. Hist. Soc. Formosa* 21: 210-216. (in Japanese).
- UENO, M. 1931a. Contributions to the knowledge of Japanese Ephemeroptera. *Annot. Zool. Japon.* 11 : 189-226.
- UENO, M. 1961. Mayflies of Thailand. Nature and Life in Southeast Asia 1 : 207-208.
- ULMER, G. 1912. H. Sauter's Formosa-Ausbeute. Ephemeroptera. *Ent. Mitt.* 1 : 369-375.
- ULMER, G. 1926. Beiträge zur Fauna Sinica. III. Trichopteren and Ephemeropteren. *Arch. Naturgesch.* (A) 91 (5) : 19-110.
- ULMER, G. 1929. Ueber einige, hauptsächlich asiatische, Ephemeropteren und Trichopteren aus der Sammlung R. McLachlans. *Deutsch. Ent. Ztschr.* 3 : 161-167.
- ULMER, G. 1939. Eintagsfliegen (Ephemeropteren) von den Sunda-inseln. *Arch. Hydrobiol.* (Suppl.-Bd.) 16 : 443-580.